

# TIMER S4

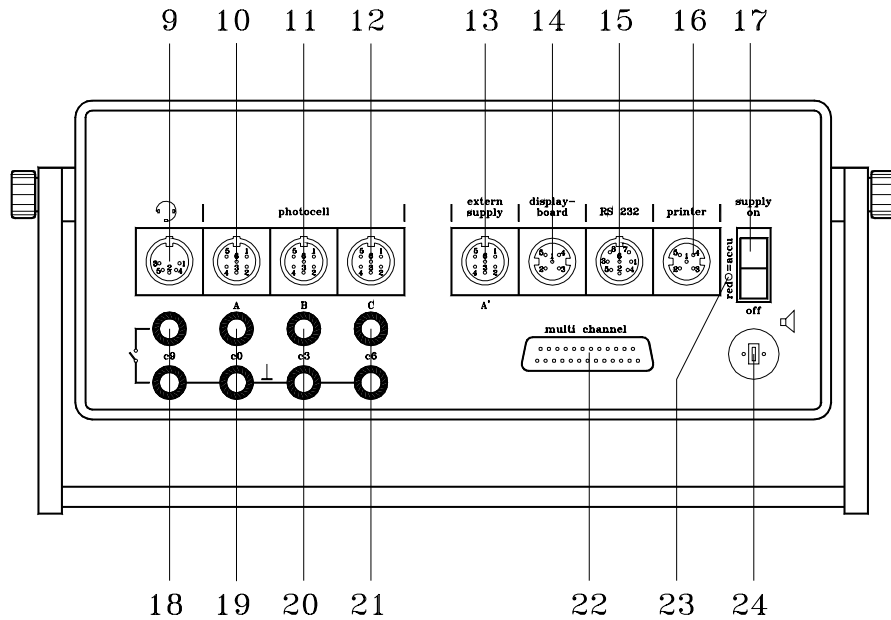

**ALGE**  
TIMING

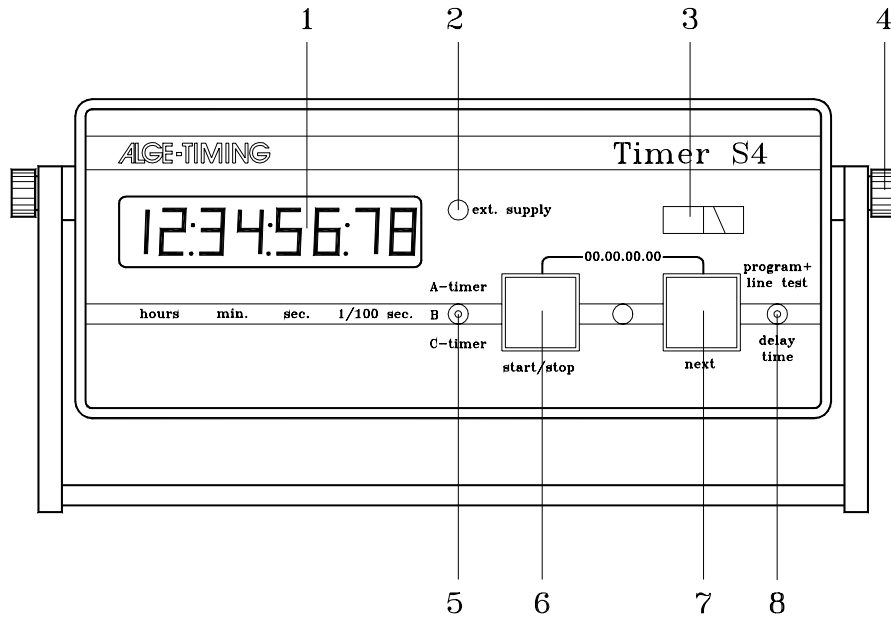

- 1 Eight-digit liquid crystal time-display in hours, minutes, seconds and hundredths of seconds. While time is running, the hundredths of seconds are not displayed.
- 2 Light emitting diode (LED) signals that the Timer S4 is supplied with 9,5 Volt. If the timer is driven by rechargeable batteries the LED is lighted when batteries are loaded.
- 3 Meter for monitoring power supply, adjustment of photocell form parcour A, B, C, and conductive condition of the start-to-finishing cable form parcour A.
- 4 Knurled screws for loosening and fixing the handle.
- 5 Toggle-switch to select clock A, B, or C. Additional functions as indicated in the instruction manual.
- 6 Start/Stop key with additional functions as indicated in instruction manual.
- 7 Recall (next) button for stored times with additional functions as indicated in instruction manual.
- 6 +7 By simultaneously pushing keys 6+7 the display as well as the preselected timer are set at zero (only net times). As long as both keys are pressed down, the display will show only number eights to allow checking of all the display's segments.
- 8 Selector toggle-switch for choosing the programs, testing the lines, and setting the options adjustments  
*Program selection:* press toggle-switch upwards and turn device with switch (17) on  
*Line test:* when pressing the toggle-switch upwards it shows the condition of line on meter (6) (see page 14)  
*Set up of options:* when pressing toggle-switch down it you can adjust the options with the red and yellow key (6+7) (see page 15)
- 9 Connection for headset Q34 (see page 54)
- 10 DIN outlet mainly used to connect the finish photocell of timer A (inputs for K0, K1, and K2). Connection of power supply (NLG4) is also possible (see page 54).
- 11 DIN outlet mainly used to connect the finish photocell of timer B (inputs for K3, K4, and K5). Connection of power supply (NLG4) is also possible (see page 54).
- 12 DIN outlet mainly used to connect the finish photocell of timer C (inputs for K6, K7, and K8). Connection of power supply (NLG4) is also possible (see page 54).
- 13 DIN outlet mainly to connect the power supply NLG4, identical with DIN outlet 10 (see page 54).
- 14 Connection for ALGE display board GAZc (see page 55).
- 15 Connection for computer (serial RS 232c interface) (see page 55).
- 16 Connection for Printer P4 (see page 55).
- 17 On/Off switch
- 18 Banana outlet (red and black) for channel 9
- 19 Banana outlet (green and black) for channel 0
- 20 Banana outlet (green and black) for channel 3
- 21 Banana outlet (green and black) for channel 6
- 22 25-pin D-Sub-Miniature outlet with all 18 channels (see page 54).
- 23 Indicates the internal setting:  
red = rechargeable batteries  
black = alkaline batteries
- 24 Outlet for count-down loud speaker (e.g. for show jumping, swimming,...)

## TABLE OF CONTENTS

1. DESCRIPTION OF DEVICE .....	4
1.1. Standard programs .....	4
2. OPERATING .....	6
2.1. Power Supply .....	6
2.2. How to connect other devices to the Timer S4 .....	9
2.3. Memory .....	12
2.4. Control Function .....	13
2.5. Line Test - Checking of the Start - Finish line .....	14
2.6. Set up of options .....	15
2.6.1. Set delay time .....	16
2.6.2. Duration of displaying time on display (1) and on a display board .....	17
2.6.3. Split, Sequential or Time-out .....	17
2.6.4. Running tenth on or off .....	18
2.6.5. Set up of the display board interface .....	18
2.6.6. Precision .....	19
2.6.7. Display automatic .....	19
2.6.8. Adjust printer options .....	19
2.6.9. Photocell distance for speed measurement .....	20
2.6.10. Adjustment for swimming .....	20
2.7. Timing impulse beep .....	21
2.8. Synchronize start .....	21
3. TIMING .....	22
3.1. SPLIT or SEQUENTIAL .....	(program 0) 23
3.2. 3-Course-Timer .....	(program 1) 26
3.3. Show-Jumping .....	(program 2) 29
3.4. 18-Channel-Timer .....	(program 3) 30
3.4.1. 18-Channel-Timer with net time .....	30
3.4.2. 18-Channel-Timer with time of day and net time .....	32
3.4.3. 18-Channel-Timer with time of day and count-down .....	35
3.5. Parallel Slalom .....	(program 4) 38
3.5.1. Parallelsalom with finish-difference-time .....	38
3.5.2. Parallelsalom with finish-difference-time and net time .....	40

3.6. Speed .....	(program 5) .....	43
3.7. Swimming .....	(program 6) .....	46
3.8. Automatic .....	(program 7) .....	47
4. DEVICES USED WITH TIMER S4 .....		49
4.1. Printer P4 .....		49
4.2. Multichannel MC18 .....		51
5. TECHNICAL DATA .....		52
5.1. Connection System .....		53
5.1.1. Photocell Jacks and External Supply .....		53
5.1.2. Headset Jack (11) .....		53
5.1.3. Loud Speaker Jack (26) .....		53
5.1.4. Display Board Jack (16) .....		54
5.1.5. Printer Jack (18) .....		54
5.1.6. RS 232c - Computer Jack (15) .....		54
5.1.7. Multi Channel Outlet (24) .....		54
5.2. Computer connection - RS 232c interface (15) .....		55
5.3. Connection for the Display Board GAZc (14) .....		60
5.4. Connection for Printer P4 (16) .....		60

## 1. DESCRIPTION OF DEVICE

The Timer S4 is the descendent of the popular S3 Timer used for over 10 years worldwide. S3 users upgrading to the S4 will find the Program "0" to be familiar with the older Split Program. We recommend that you start your use of the S4 with Program "0" first as a tutorial.

The Timer S4 is equipped with the most modern CMOS microelectronics. Universal software allows the timer to be used for a variety of applications. Many aspects of the software have crossover applications for other sports as well. All previously manufactured ALGE sensors and accessories will work to 100% effectiveness.

- Temperature compensated quartzoscillator (TCXO), for the highest timing precision possible.
- 18 timing channels
- You can store up to 8000 times in the memory. Every timing impulse is automatically stored with a continuous ID number.
- Storage of memory even when device is turned off
- Battery box located in the bottom of the case for security against leakage.
- Battery powered by either "C" cell alkaline or NiCads.
- Communication on six channels is possible.
- Connections for the following devices are available:
  - o ALGE Printer P4
  - o ALGE display board GAZc
  - o ALGE photocell RLS1c, RLS1cd, or RLS3c
  - o ALGE startgate STSc
  - o ALGE headset Q34
  - o RS 232c interface to connect a computer

**Press red and yellow button (6+7) at the same time:**

When described in the text: press red and yellow button (6+7) at the same time you have to do the following:

- press yellow button (7) and continue holding it down
- press red button (6)
- release red and yellow button (6+7)

### 1.1. Standard Programs:

<b>Program</b>	<b>Program-Number</b>	<b>Discription</b>
Split or Sequential	Prog 0	Page 24
3-Course-Timer	Prog 1	Page 27
Show-Jumping	Prog 2	Page 30
18-Channel-Timer	Prog 3	Page 31
Parallel Slalom	Prog 4	Page 39
Speed	Prog 5	Page 44
Swimming	Prog 6	Page 47
Automatic	Prog 7	Page 48

**SPLIT or SEQUENTIAL Prog. 0 see page 24**

Net-timing for events with single start. It is possible to have three competitors at the same time on the slope. Any number of intermediate times are possible.

**3-Course-Timer Prog. 1 see page 27**

Net-timing for events with three race tracks (three separate start and finish).

**Show Jumping Prog. 2 see page 30**

We have a special manual for show jumping. Please ask your ALGE-dealer for this manual.

**18-Channel-Timer (Time of Day Printer) Prog. 3 see page 31**

Timer with one start channel and 17 separate stop channels. It is also possible to time with a time of day and net-time

**Parallel Slalom Prog. 4 see page 39**

Timing for parallel slalom or persuat. There is a program, that measures only the finish difference time, and one measuring the net time of both competitors as well as the finish difference time.

**Speed Prog. 5 see page 44**

Speed measurement between to points (one direction). Measurement distance is adjustable from 1 to 180 m. The measurement is in km/h, m/s or mph.

**Swimming Prog. 6 see page 47**

Timing for swimming. If you use this program together with the touch pad TP1 and the start acoustic SA1, then you need the separate manual for swimming.

**Automatic Prog. 7 see page 48**

Net-timing program that runs the Timer S3 automatic (no operator is necessary). You can input the amount of impulses per competitor. As soon as a competitor receives all impulses, it resets the clock and the next is able to start.

## 2. OPERATING

### 2.1. Power Supply:

- Input of 6 alkaline "C" cell batteries with 1,5 Volt or 6 NiCad-"C" cell rechargeable batteries with 1,2 Volt (see picture below or in the battery case) .

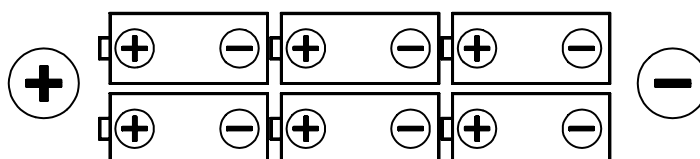

*Attention:* Take the alkaline batteries out of the Timer S4 at the end of a season. A leaking battery could destroy the device!

Please respect the environment. Return your batteries to a recycling station or dispose of them in another proper manner.

- Battery test: turn Timer S4 on. If the needle of the meter (3) is in the green field you have enough power.

*Attention:* When using the ALGE Printer P4 you must use the NiCad rechargeable batteries.

**You have the following possibilities of power supply:**

- o 6 Alkaline "C"-cell-batteries with 1,5 Volt
- o 6 NiCad "C"-cell-batteries with 1,2 Volt.  
**Charging time:** about 14 hours

*Attention:* If you input NiCad batteries yourself (e.g. if you buy at a later point the Printer P4), please contact your ALGE dealer. He will tell you how to activate the internal charging circuit.

- o If you have AC power you can supply the Timer S4 with the power supply NLG4 direct. The batteries will function as a back up in case of power failure.

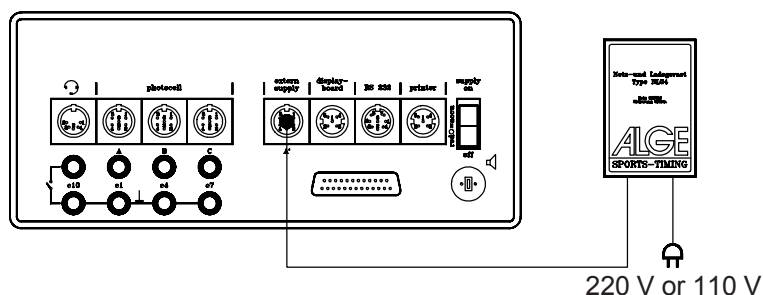

- o NiCad batteries should be checked individually with a voltmeter every 6 months to determine if they are holding a charge properly. Replace any individual battery that drops below the 1.2 volt level.  
NiCad batteries have a useful service life of 4-5 years.
- o Replace your Alkaline batteries prior to an important meet. It is inexpensive insurance against failure. Use the older batteries up in your flashlight or put them in the kids toys (they won't know the difference).
- o Connection to an external battery (12 V, about 5 Ah): we deliver on request the correct battery cable (005-02). The internal batteries are used to back up.

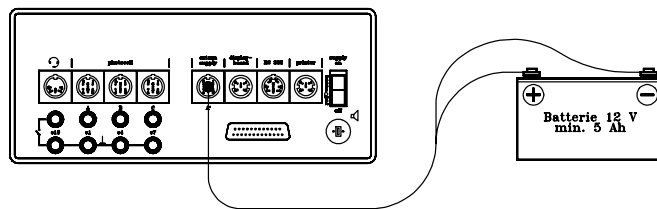

**Adjustment of the Timer S4 for rechargeable- or alkaline batteries:**

On the backside of the Timer S4 is a hole (23), which indicates if the S4 is set up for alkaline or rechargeable batteries.

- hole (23) is red, which means it is set up for rechargeable batteries
- hole (23) is black (dark), which means it is set up for alkaline batteries

If the timer is set for rechargeable batteries never use normal batteries and use the net-charging device NLG4 at the same time.

**Charging condition of batteries:**

You can check the condition of the batteries by pressing toggle switch (8) upwards (position program/line test). It shows now in the display (1) the program number, the memory in use, the baud rate of interface "display board", "printer" and "RS 232", as well as the voltage of the batteries.

Use the following table only as approximate value. The batteries from different companies have different characteristics as well as the temperature changes the battery condition.

Battery Condition	Alkaline Battery	NiCd Rechargeables	Needle of Meter
Full	about 8,7 Volt	about 7,2 Volt	green/black
3/4 full	about 8,1 Volt	about 6,9 Volt	green
1/2 full	about 7,5 Volt	about 6,9 Volt	green
2/4 full	about 6,9 Volt	about 6,9 Volt	green
empty	about 6 Volt	about 6 Volt	green/red

**Approximate duration of NiCd- and alkaline batteries:**

	<b><i>NiCd-rechargeables</i></b>	<b><i>Alkaline batteries</i></b>
S4 with one RLS1c, without printer	28 hours	112 hours
S4 with three RLS1c or one RLS3c without printer	16 hours	64 hours
S4 with one RLS1c, with Printer P4 (every 30 seconds one print)	24 hours	96 hours
S4 with three RLS1c or one RLS3c with Printer P4 (every 30 seconds one print)	12 hours	48 hours

At temperatures of -20°C is the duration of a battery about 20% less.

The measurement was done with ALGE photocells RLS1c and the ALGE Printer P4 at a temperature of 20°C.

When using an ALGE Printer P3 it has about the half duration time written in the last two lines in the above table.

## 2.2. How to connect other devices with the Timer S4:

### Start connections:

- o **Start-, intermediate- or stop impulse for a handswitch:**  
 Start-handswitch with banana plug: Cable no.. 023-02 or 023-10  
 Intermediate-handswitch (DIN plug): Cable No. 022-02  
 Start-handswitch (DIN plug): Cable No. 024-02  
 Stop-handswitch (DIN plug): Cable No. 020-02

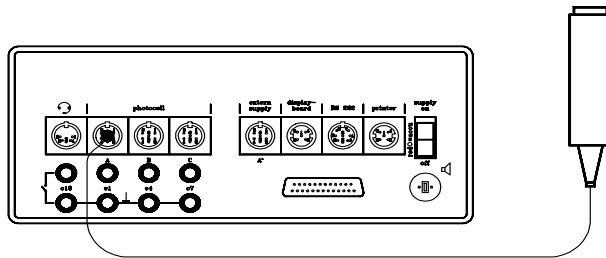

- o **Start impulse form Startgate STSc:**  
 1 pair cable with banana plug (e.g. ALGE cable reel KT300 or KT500)

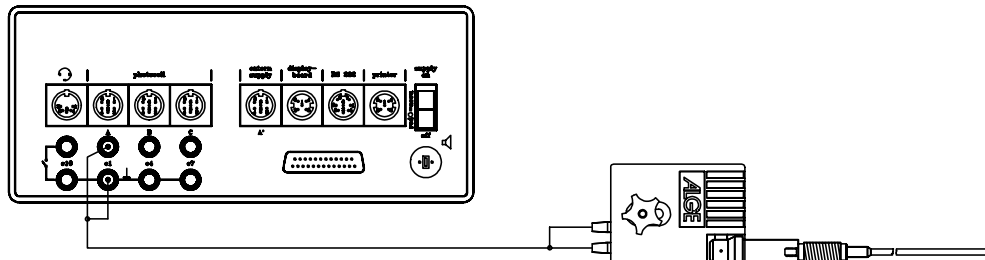

- o **Start impulse from Photocell RLS1c:**  
 Start-finish distance over 100 m  
 Cable reel with 1 pair cable from Timer S4 to RLS1c,  
 use adapter 027-02 to activate photocell

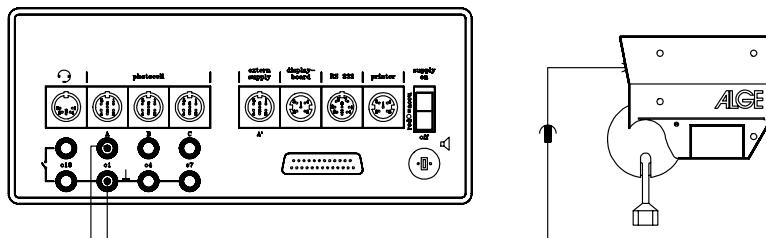

- o **Start impulse from Photocell RLS1c:**  
 Start-Finish distance less than 100 m (e.g. cable 002-10)

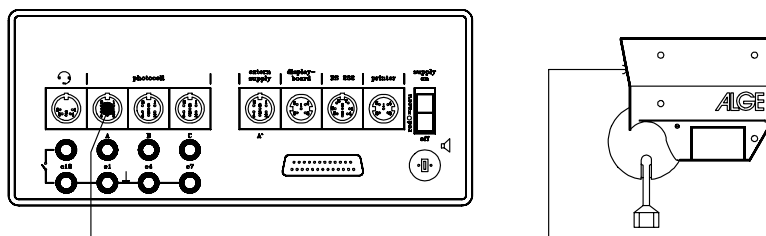

o **Start impulse from Startmicrophone (Startgun):**

Cable reel with 1 pair cable from Timer to SV3/SM6

Attention: notice polarity of cable! Polarity is correct if LED of SM6 is blinking.

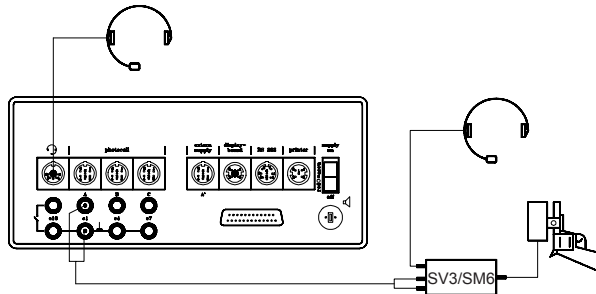

o **Intermediate time form the Photocell RLS1c:**

Cable length is less than 100 m (e.g. cable 003-10)

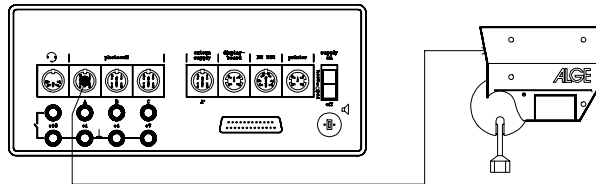

Cable length is more than 100 m

Use cable reel with 1 pair cable and adapter 027-02 to connect 1 pair cable with photocell, as well as cable 092-02 as adapter for the timer.

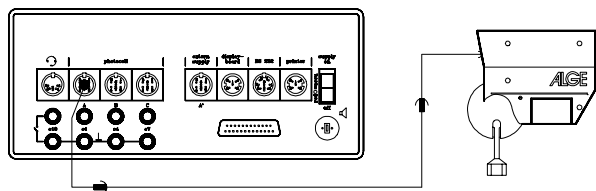

o **Stop impulse Finish form Photocell RLS1c or RLS3c:**

Cable length less than 100 m (e.g. cable 001-10)

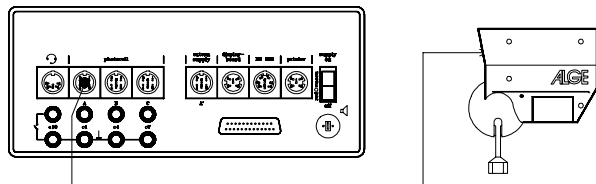

o **Stop impulse Finish from Photocell RLS1c or RLS3c:**

Cable length is more than 100 m

Use cable reel with 1 pair cable and adapter 027-02 to connect 1 pair cable with photocell and Timer S4.

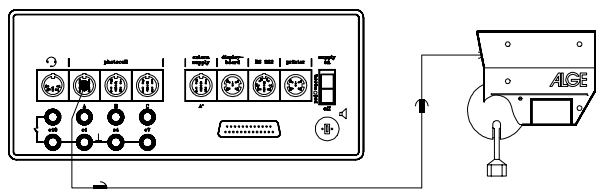

o **Printer P4:**

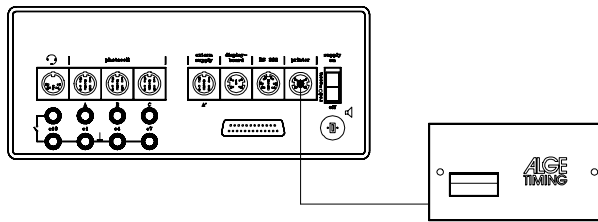

o **Display board GAZc with Cable No. 010-10:**  
for distances over 10 m (e.g. with ALGE cable reel KT300)

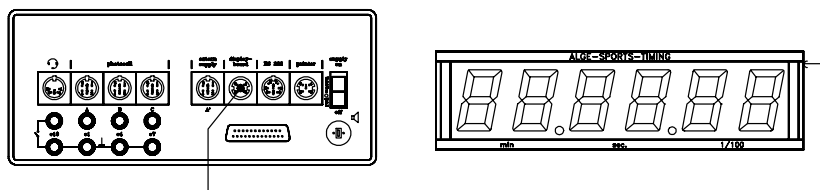

o **Start - Finish communication:**

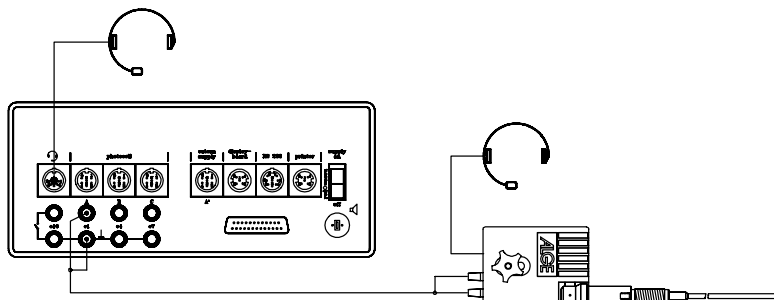

o **Speaker for acoustic count-down:**

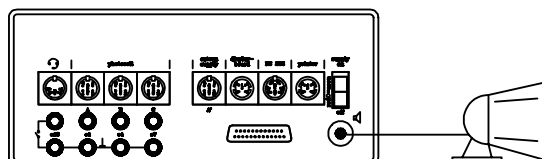

o **Power supply of Timer S4 with a 12 Volt battery through cable 005-02:**

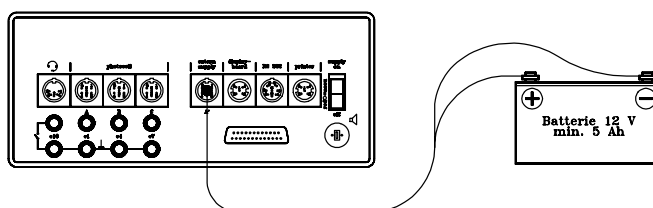

## **2.3. Memory:**

This feature is designed to allow users of the S4 with a computer interface to access times stored in memory. You must use a computer to take advantage of this feature. The default setup from the factory has the S4 automatically recording all times up to 8000. When turning the device on it shows you on the display how much memory is occupied:

- FULL: 0.0 ..... memory is empty, free memory capacity is about 8000 times
- FULL: 0.5 ..... memory is 50% full, free memory capacity is about 4000 times
- FULL: 1.0 ..... memory is full, you need to clear the memory

The memory can store up to 8000 times with a continuous ID number assigned to each time (see data format of each program). During operation you can control the free memory space with the control function (see next page). If you plan to download data from the memory clear the S4 prior to the competition.

### **Clear Memory:**

There are two ways to clear the memory:

- o from the RS 232 interface:
  - A hexadecimal code is transferred from a computer through the RS 232 interface (see page 56, chapter 5.2.).
- o when turning the S4 on:
  - press toggle switch (8) to upper position
  - turn device on (switch 17)
  - release toggle switch (8)
  - select program with the yellow key (7)
  - press toggle switch (8) to upper position
  - display (1) shows "CLr nEln" (= clears memory not)
  - press yellow button (7)
  - display (1) shows "CLr JA" (= clears memory)
  - press red and yellow button (6+7) at together
  - memory will be cleared each time you turn the device on, as long as you do not switch back to "CLr nEln".

During the timing mode you can check the adjustment for the memory by pressing the toggle switch (8) to the upper position (see page 15, chapter 2.6.).

### **Transmission of the memory:**

You can transmit the memory at any time during the operation of the Timer S4. The transmit order must be given by the computer through the RS 232 interface. The Timer S4 starts to transmit as soon as it receives the hexadecimal code 85 (see page 58, "Memory output").

### **Memory output in blocks:**

It is possible to output a block of data from the memory (RAM) of the Timer S4 using the RS 232 interface (15). You have to input the hexadecimal code 84, the first address and the last address in ASCII.  
e.g.: 84(Hex)09341330 = output of all data from memory number 934 to 1330 through the RS 232 interface

## **2.4. Control Function:**

As soon as the Timer S4 is in timing function you can control some of the adjustments on the display.

- press toggle switch (8) to the upper position
- on the display (1) it shows in the following order:
  - o program number and version
  - o occupied memory space
  - o if it clears the memory when turning the device on
  - o baud rate of interface 1: display board (14)
  - o baud rate of interface 2: printer (16)
  - o baud rate of interface 3: RS 232 (15)

*Program number and version:*

e.g.: Pr.1 V92.E = program number 1, Version 92 E

*Occupied memory space:*

FULL: 0.0 ..... memory is empty, free memory capacity is about 8000 times

FULL: 0.5 ..... memory is 50% full, free memory capacity is about 4000 times

FULL: 1.0 ..... memory is full, you need to clear the memory

*If it Clears the memory when turning the device on:*

CLR. JA it clears the memory when turning the device on

CLR. nEIn it does not clear the memory

*Baud rate of interface 1: display board (14)*

pre adjustment: 2400 baud

possible adjustments: 19200, 9600, 4800, 2400 Baud

adjustment: see page 59 and 61

*Baud rate of interface 2: printer (16)*

pre adjustment: 2400 baud

possible adjustments: 19200, 9600, 4800, 2400 Baud

adjustment: see page 59 and 61

*Baud rate of interface 3: RS 232 (15)*

pre adjustment: 4800 baud

possible adjustments: 9600, 4800, 2400, 1200 Baud

adjustment: see page 56 and 58

## **2.5. Line Test - Checking of the Start - Finish Line:**

Checking of the 1 pair cable which is connected at banana socket A (19). Turn the Timer S4 on (switch 17) and choose any program:

### **o Short-circuit-Test:**

- Cable is open at the start side
- Press toggle switch (8) upwards (direction "line test")
- Needle of meter (3) must stay in the middle of the green area (otherwise short-circuit)

### **o Resistance-Test:**

- Short the pair on the start side (press banana plug together)
- Press toggle switch (8) upwards (direction "line test")
- Needle of meter (3) must go to the far left side (otherwise is the resistance too high; maximum 2000  $\Omega$  loop resistance).  
Needle is at 2000  $\Omega$  about 1 mm before the left end.

The line test meter is only for quick reference. Please use a multimeter set on Ohms for accurate testing of your wiring. Remember that resistance on the line will change due to weather conditions. Always check the condition of splices, especially in extremely cold temperatures. Scotchlocks and AMP locks have a bad habit of opening due to the expansion rate differences between the copper wire and the steel splicing plate. You should use the older "White Bean" connectors if there is a chance that temperatures will fall to below -10 F (-15°C).

Most of the problems with timing installations are due to wiring on the course. Please take the time to review your wiring early in the season. Bad splices and connections will only get worse as time goes on and they are a lot easier to deal with in the Fall before the pedestals get covered with snow.

Please call your ALGE agent for assistance with wiring. They are able to consult with you on proper wiring plans and are usually available to travel to your site for more detailed work at reasonable expense.

### **Needle of meter (3) swings:**

The needle of the meter starts to swing as soon as the photocell is out of line. Please check the set up of the photocell. A swinging needle could also be caused during a very long timing impulse or through a short-cut of the cable.

## 2.6. Set up of Options:

The Timer S4 is a very universal device. In order to have a universal device, it is necessary that the user is able to adjust some features.

The default language used for most of the options is German.

AUS = OFF  
EIN = ON  
JA = YES  
NEIN = NO  
LF = RUNNING TIME  
CH = CHANNEL  
LZE = RUNNING 10ths

If you change options, they will be stored even after turning the device off.

If you want to have to the original default set up of the options, then do the following:

- turn Timer S4 off (switch 17)
- press yellow button (7) down
- press toggle switch (8) upwards (position program+line test)
- turn Timer S4 on (switch 17)
- release yellow button (7) and toggle switch (8)
- choose program with the yellow button (7)

You can set the following options (depending on the program you use):

- **dF**      **delay time finish**  
                 0.02 to 0.99 and 1.0 to 9.9 seconds
- **dS**      **delay time start**  
                 0,0 to 9.9 seconds
- **SLP**     **duration of displaying time on display (1) and on a display board**  
                 only for program *18-Channel-Timer*, 0,0 to 9,9 seconds
- **SE or TO**     **split, sequential- or time-out**  
                 for program SPLIT or SEQUENTIAL you can switch between split or sequential mode;  
                 for program *18-Channel-Timer* with time of day you can switch channel 9 between sequential and time-out
- **nET**     **net time on or off**  
                 only for program *18-Channel-Timer with time of day* for interface display board (14)
- **LZE**     **running tenth on or off**  
                 AUS = running tenth off  
                 Ein = running tenth on
- **LF**      **running time for display board interface**  
                 LF-CH1-2 = running time is on channel 1 and 2 on  
                 LF-CH1 = running time is on channel 1 on

- **TAU thousandth on or off**
  - AUS = thousandth off
  - EIN = thousandth on
  
- **HUn hundredth on or off**
  - AUS = hundredth off
  - EIN = hundredth on
  
- **AUT display automatic on or off**
  - EIN = you can set the display time with variable SLP
  - EINL = only the first time will be shown on the display board
  - AUS = manual change of display with yellow key (7)
  
- **Pri printer speed (set up 60 for Printer P3)**
  - Input range: 0 to 9.9 (0 = off, 0.1= fast, 9.9 = slow)
  
- **Lr line feed for printer**
  - Input range: 0 to 9 (amount of line feeds after each line)
  
- **di. photocell distance for speed measurement**
  - Input range: 1 to 180 Meter
  
- **A00 Amount of touches for swimming**
  - Input range: 0 to 99 touches
  
- **n01 competition number and running number for swimming**
  - Input range: 0 to 99

#### **How to set the options:**

- o press toggle switch (8) upwards (program+line test)
- o turn Timer S4 on (switch 17)
- o release toggle switch (8) when display (1) shows 8.8:8.8:8.8.88
- o select program with yellow button (7)
- o press yellow and red button (6+7) together
- o program is ready for timing
- o press toggle switch (8) downwards (delay time)
- o changing of options is now possible
- o increment choices with yellow and red button (6+7) red button is for left of the decimal, yellow for right
- o press toggle switch (8) downwards (delay time) to set the next variable

#### **2.6.1. Set delay time:**

#### **dF and dS**

Time to prevent accidental recording of extra impulses. You will need to experiment with this feature somewhat as it will change between sports and the start interval that determines the likelihood of athletes bunching up as they approach the finish.

The delay is designed to prevent the timer from receiving another impulse from the same channel for a definite time after an impulse. You can set the delay time separate for the start channels and finish channels.

**Finish delay time (dF):**

- o set the display (1) on 0:00.00 (press red and yellow button (6+7) together)
- o press toggle switch (8) downwards (delay time)
- o it show on the display (1) the finish delay time (dF = delay time finish)
- o increase delay time by 0.01 seconds by pressing the yellow button (7), or 0.1 seconds by pressing the red button (6)
- o you can switch the finish delay time to the second mode by pressing the toggle switch (8) to the upper position. Now change the seconds by pressing the red button (6) and the 1/10 seconds by pressing the yellow button (7).
- o when start delay time is set press red and yellow button (6+7) at once
- o the new delay time is now stored and the Timer S4 is ready for timing

**Attention:** Set the finish delay time for alpine skiing quite long (about 0.7 sec.), because a competitor should not be followed by another within a short time. For cross country skiing you need a shorter finish delay time, because the competitors can cross the line closely after one another. On the other hand if you choose a very short finish delay time it gives you more impulses (e.g. both legs make you an impulse).

EXPERIMENT BEFOREHAND!!!

The S4 will BEEP for the entire time of the delay (max. 2 seconds). This is normal.

**Start delay time (dS):**

If the display (1) shows the finish delay time (dF) you can adjust the following:

- o press toggle switch (8) to lower position "delay time"
- o it shows in display (1) the start delay time (dS = delay time Start)
- o increase delay time by 0.1 seconds by pressing yellow button (7), or 1 second by pressing red button (6)
- o when start delay time is set press red and yellow button (6+7) at once
- o the new delay time is now stored and the Timer S4 is ready for timing

The S4 will BEEP for the entire time of the delay (max. two seconds). This is normal.

**2.6.2. Duration of displaying time on display (1) and on a display board: SLP**

This can be set only in the program *18-Channel-Timer*, *Speed*, and *Automatic*. You can set the time during which a stopped time is shown on the display board.

- o input range: 0,0 to 9,9 seconds

The "display automatic" must be on (see page 20, chapter 2.6.7.) in order to have a function of SLP.

**2.6.3. Split, Sequential or Time-out SE or TO**

Using program 0 "SPLIT or SEQUENTIAL" you can set the split- or sequential mode.

- o SE AUS SPLIT-mode is on
- o SE EIN SEQUENTIAL-mode is on

Using program 3 "18-Channel-Timer with time of day" you can set if channel 9 (red banana socket, 18) is used for sequential timing or time out.

- o SE nod Sequential (lap timing) on channel 9 (banana socket 18)
- o TO nod Timer-out on channel 9 (banana socket 18)

Using program 3 "18-Channel-Timer with time of day and count-down" you need to set the following:

- o SE nodC Count-down with sequential (lap timing) on channel 9 (banana socket 18)
- o TO nodC Count-down with timer-out on channel 9 (banana socket 18)

Set SE nodC or TO nodC by pressing toggle switch (8) to upper position when display shows SE nod or TO nod.

**2.6.4. Running tenth on or off: LZE**

If you turn the running tenth on then it shows the running tenth on the display (1) and you have an output through the serial interface.

- o LZE Ein = running tenth on
- o LZE AUS = running tenth off
- o With the yellow button (7) you switch the running tenth on or off.

If you insert the time for TV, you should have the running tenth on.

**2.6.5. Set up of display board interface (14): LF, nET**

Normally you have the following set-up: LF-CH1-2 and SEC AUS

**Running time for display board interface: LF**

*Running time or run time:*

Plug the display board into socket (Display Board 14). You can turn the plug 180° (two different channels, see page 61 chapter 5.3.)

channel 1: running time

channel 2: changing between running time or run time is possible

- o LF-CH1-2 = output of running time on channel 1 and 2
- o LF-CH1 = output of running time on channel 1, output of run time on channel 2
- o Press the yellow button (7) to change channel 2

*Address for display board GAZc:* Normally the output is without address (thumb wheel switch of display board is on position 0). If you have an output with address you can show on different display boards different times. A address for the output is possible with the following programs:

- 3-Course-Timer
- Parallelsalom with finish-difference time and net time

Activating the address:

- display (1) shows "LF CH1-2"
- press toggle switch (5) to upper position
- display (1) shows "LFACH1-2"

The address activation is not stored after turning the device off. You have to activate it every time.

A description of how to set-up the display board you can find in the specified program description.

#### **Net time on or off: nET**

This function is only active in program 3 "18-Channel-Timer with time of day" and "18-Channel-Timer with Count-down". You can choose the output of the net time through interface "Display Board" (14). If you output the net time and time of day the baud rate changes automatically from 2400 to 4800 baud.

**Attention:** Be advised that if you choose this option you will have to replace the EPROM in the GAZc display board to 4800 baud.

- o nET AUS output of time of day (display board 14)
- o nET EIN output of time of day and net time (display board 14)

#### **2.6.6. Precision:**

#### **TAU, HUn**

You can set the precision of the timing. The following set up is possible:

Precision = 1/1000 seconds:	TAU EIN
Precision = 1/100 seconds:	TAU AUS and HUN EIN
Precision = 1/10 seconds:	TAU AUS and HUn AUS

- o switch with yellow button (7) between on = EIN and off = AUS
- o switch with toggle switch (8) from TAU to HUn

*1/1000 seconds shown on the display:*

The display (1) shows normally 1/100 seconds (exception is the Parallel Slalom program). If you need to show the 1/1000 seconds on the display do the following:

- display (1) shows "TAU Ein"
- press toggle switch (5) to upper position
- display (1) shows "TAU EIn"

If you switch the 1/1000 seconds in the display (1) on it will not show the hours.

**2.6.7. Display automatic:****AUT**

You can adjust the display time of display (1) and the display board manual or automatic. If the automatic is on (AUT EIn) it will show the time as long as "SLP" (see page 17 chapter 2.6.2.) is adjusted.

If the automatic is turned off (AUT AUS) "SLP" has no function.

- o AUT EIn     automatic display is on
- o AUT EInL   display shows always the first time (e.g. for track and field)  
                  change to actual time by pressing the yellow button (7)
- o AUT AUS     automatic display is off
  
- o change from on (EIn) to off (AUS) be pressing the yellow button (7)
- o Press toggle switch (8) to upper position to change from "AUT EIn" to "AUT EINL"

**2.6.8. Adjust Printer options:****Pri, Lr**

You can adjust the following options for the printer:

- Printer speed       Pri
- Line Feed           Lr

**Printer Speed   Pri:**

Speed for sending data strings to the printer.  
Input range from 0 to 9.9

- o increase printing speed by 0.1 by pressing yellow button (7)
- o increase printing speed by 1 by pressing red button (6)
  
- 0       printer off
- 0.1     very fast data strings to the printer (buffer is necessary, Printer P4)
- 6.0     data strings are sent every second (Printer P3)
- 9.9     for very slow printers

Printer P4:       best adjustment is 0,1  
Printer P3:       best adjustment is 6.0

The Timer S4 can buffer up to 60 times before they are sent to the printer.

**Carriage Return for Printer   Lr:**

You can adjust the amount of Carriage Return from 0 (prints into each line) and 9 (after each printed line are 9 empty lines).

- o increase the line feed by pressing the yellow button (7)
  
- o Experiment to find the best number of returns. You will want the times to be forwarded a couple of lines above the cutter, but not as much as to waste paper.

**2.6.9. Photocell distance for speed measurement:****di.**

You have to input the photocell distance for speed measurement (program 5). The distance is adjustable from 1 to 180 m.

- o increase by 10 Meter increments by pressing the red button (6)
- o increase by 1 Meter increments by pressing the yellow button (7)

**2.6.10. Adjustments for swimming:**

You have to input the following for the swim-program (program 6):

- o amount of touches per line (from 1 to 99) A
- o competition number (from 1 to 99) n
- o running number (from 1 to 99) n
- o finish-delay time (from 10 to 99 seconds) dF

## **2.7. Timing impulse beep:**

The Timer S4 makes a beep for every timing impulse. The duration of the beep is equivalent to the adjusted delay time (maximale 2 seconds).

You can switch the tone of the beep on or off by pressing the toggle switch (8) to the upper position when receiving a stop impulse.

## **2.8. Synchronize start:**

A synchronized start is a feature which allows a start impulse from the S4 to transmit through all start channels to start other timers. A synchronized start is necessary to start different timing devices at the same time in order to meet the timing regulation of the FIS and other federations.

### **Making a synchronize start:**

all programs except 18-Channel-Timer with time of day)

- connect all timers with synchronize cable 004, or banana plug jumper coming out of channel "A" (19) to the banana plug inputs of the other timers.
- adjust Timer S4 that the display shows "0:00.00" (A-timer, B-timer and C-timer)
- press red and yellow button (6+7) together -the display must show "SY 0:00:00"
- make all other timers ready for a synchronize start (all devices have to be connected by cable 004, or banana plug jumper)
- by pressing toggle switch (8) downwards it makes a synchronize start
- all connected timers show now a running time on the display

### **Synchronize start for 18-Channel-Timer with time of day:**

- connect all timers with synchronize cable 004 (or banana plug jumper)
- adjust Timer S4 that the display shows "0:00.00" (A-timer, B-timer and C-timer)
- press red and yellow button (6+7) together
- the display (1) must show "HP 0:00:00"
- input time of day (red button (6) = hours; yellow button (7) = minutes)
- make all other timers ready for a synchronize start (all devices have to be connected by cable 004)
- by pressing toggle switch (8) downwards it makes a synchronize start
- all connected timers show now a running time on the display

### **3. TIMING**

In order to select a program you have to press the toggle switch (8) upwards (position program+line test) during turning the device on (switch (17)). Now you can select the program by pressing the yellow button (7). The display shows the program number and version number of the software.

If you turn the Timer S4 on (switch 17), without pressing the toggle switch (8) upwards, the program that you used before will be selected automatically.

<b>Program</b>	<b>Program-Number</b>	<b>Discription</b>
Split or Sequential	Prog 0	Page 24
3-Course-Timer	Prog 1	Page 27
Show-Jumping	Prog 2	Page 30
18-Channel-Timer	Prog 3	Page 31
Parallel Slalom	Prog 4	Page 39
Speed	Prog 5	Page 44
Swimming	Prog 6	Page 47
Automatic	Prog 7	Page 48

Each program has pre-adjusted options (e.g. delay time, precision, ...). This options you can change when using the program. After you turn the device off it keeps the changed options in the memory.

If you want to have the pre-installed options from ALGE back do the following:

- turn device off (switch 17)
- press the yellow button (6) down
- press toggle switch (8) upwards (position "program+line test")
- turn device on (switch 17)
- release yellow button (6) and toggle switch (8)
- select program with yellow button (6)

#### **Headset Q34 connections:**

The S4 serves as the heart of your communications system. The built in amplifier allows you to communicate on 6 channels using the Q34 headsets. The ALGE STSc series of start gates have built in amplifiers. The SV3 amplifier is designed to work with a single pair of wires for an intermediate station or at the finish line or at the start for more flexibility.

Channels that allow to connect the headset are:

channel 0, 1, 2, 3, 6, and 9 (see page 52 and 53)

### **3.1. SPLIT or SEQUENTIAL (program 0):**

Net timing for events with single starts and up to three competitors on the course (e.g. ski alpine). All three clocks run separately during the program SPLIT or SEQUENTIAL.

You can choose between the program SPLIT or SEQUENTIAL by pressing toggle switch (8) (see page 18 chapter 2.6.3.)

- SE EIn = Program works in "Sequential" Mode (lap timing)
- SE AUS = Program works in "Split" Mode (intermediate timing)

#### ***Choose the program:***

- press toggle switch (8) upwards (position "program+line test")
- turn device on (switch 17)
- release yellow button (6) and toggle switch (8)
- select program 0 with yellow button (6)
- if the display (1) shows "Pr.0" and the version number, press the red and yellow button (6+7) together
- program SPLIT or SEQUENTIAL is ready for timing

#### ***Start:***

- the first start impulse starts the clock who is chosen by toggle switch (5)
- the second start impulse starts automatically the next clock
- the third start impulse starts automatically the third clock
- if all three clocks are running it is shown by blinking ":" on the display (1)
- no start is possible until the reset of one clock by pressing the red and yellow button (6+7) at once and the display (1) shows "0:00.00"

#### ***Finish with one competitor on the course:***

- keep toggle switch (5) always on the same position
- the first stop impulse will be seen on display (1) (there is no difference if the stop impulse is coming from red button (6) or as an external impulse). Each further stop impulse will be stored
- all stored times will be displayed and printed by pressing the yellow button (7)
- press the yellow button (7) if you have a false finish. The timer will resume running time and then accept the true finish
- reset the clock to "0:00.00" by pressing the red and yellow button (6+7) at the same time

#### ***Finish with three competitors on the course:***

- if a competitor starts on clock A he needs to receive his finish impulse on clock A (toggle switch 5 on position A-timer)
- if a competitor starts on clock B he needs to receive his finish impulse on clock B (toggle switch 5 on position B-timer)
- if a competitor starts on clock C he needs to receive his finish impulse on clock C (toggle switch 5 on position C-timer)

This feature will allow you to increase the volume of racers on a single course. The system works just like the S3 but with the addition of the third course. Rotate the racers through in a similar manner. 1=A, 2=B, 3=C, 4=A, etc.

If you do not know on which clock the competitor started:

- press and hold the yellow button (7) down until the competitor is past the finish line.
- all courses' times are stored on all three clocks
- search for the logical time by toggling between the different timers
- resume timing on the other courses if necessary by pressing the yellow button (7) on that course

THIS IS AN ADVANCED FEATURE THAT YOU SHOULD PRACTICE USING!

**Output of times on display (1) and Printer P4:**

- toggle switch (5) on position "A-timer"
- recall time after time in chronological order with yellow key (7)
- it shows the running time on the display (1) as soon as the memory is empty
- if timer A was not started it shows "0:00.00" in the display (1)
- toggle switch (5) on position "B-timer"
- recall time after time in chronological order with yellow key (7)
- it shows the running time on the display (1) as soon as the memory is empty
- if timer B was not started it shows "0:00.00" in the display (1)
- toggle switch (5) on position "C-timer"
- recall time after time in chronological order with yellow key (7)
- it shows the running time on the display (1) as soon as the memory is empty
- if timer C was not started it shows "0:00.00" in the display (1)

**Reset of the clock:**

- choose the clock with toggle switch (5) which you want to reset.
- press at the same time the red and yellow button (6+7)
- the display (1) shows "0:00.00", this clock is ready for the next start

**Pre-adjustment of the options:**

dF-30	finish-delay time = 0.3 seconds
dS-1.0	start-delay time = 1 second
SE AUS	split-mode is on
LZE = AUS	running tenth seconds are off
LF CH1-2	running time for display board interface is on channel 1 and 2
TAU AUS	precision is 1/100 seconds
HUN Eln	precision is 1/100 seconds
Pri 6.0	printer speed for Printer P3
Lr 0	printer prints in every line

**Printer P4:** example of a print output:

A	0:15.97	- times of A-timer are marked with A
B	0:15.83	- times of B-timer are marked with B
C	0:16.18	- times of C-timer are marked with C
A	0:15.99	
B	0:16.01	
C	0:15.93	

### Display board GAZc:

You can display the net time on a ALGE display board GAZc. The position of toggle switch (5) directs which time is show on the display board (and display 1).

*Data channel 1 (running time):* This output is the same as display (1). A finish time stays on the display until you press the yellow button (7). Now it shows the next finish time or the running time.

*Data channel 2 (finish time):* It shows always the last finish time.

*Attention:* : You can turn the plug of the display board cable 180°. By turning the plug you switch between running time and finish time, if it is set on LFCH1 (see page 18, chapter 2.6.5.).

### Computer output through RS 232 interface:

The interface from Timer S4 to a computer is socket RS 232 (15). Interfacing a computer with a Timer S4 is very easy. Please consult your ALGE agent for information for cables and software.

**Transfer format:** 4800 baud, 1 start bit, 8 ASCII-bit, no parity-bit, 1 stop bit

**Data format:** #####xxAxxHH:MM:SS.zht (CR)

##### ..... continuous ID number (4-digits)  
A..... identification for A-timer, B-timer or C-timer  
HH:MM:SS.zht ..... time in hours, minutes, seconds and thousandths  
x ..... blank  
(CR) ..... carriage return

### Connection for external devices (10, 11, 12 and 13):

- socket A (10), B (11), C (12), and A' (13) are all identical

**3.2. 3-COURSE-TIMER (program 1):**

Net timing with up to three courses, which means three separate race courses, three separate start inputs and three separate finish inputs

This program incorporates many new features designed to make the timing of 3 separate courses safe and logical. The timer knows which channel the start or finish impulse comes from and then keeps it in memory until you select it with the toggle switch (5). The printer, the LCD display and the display board will then show the selected information.

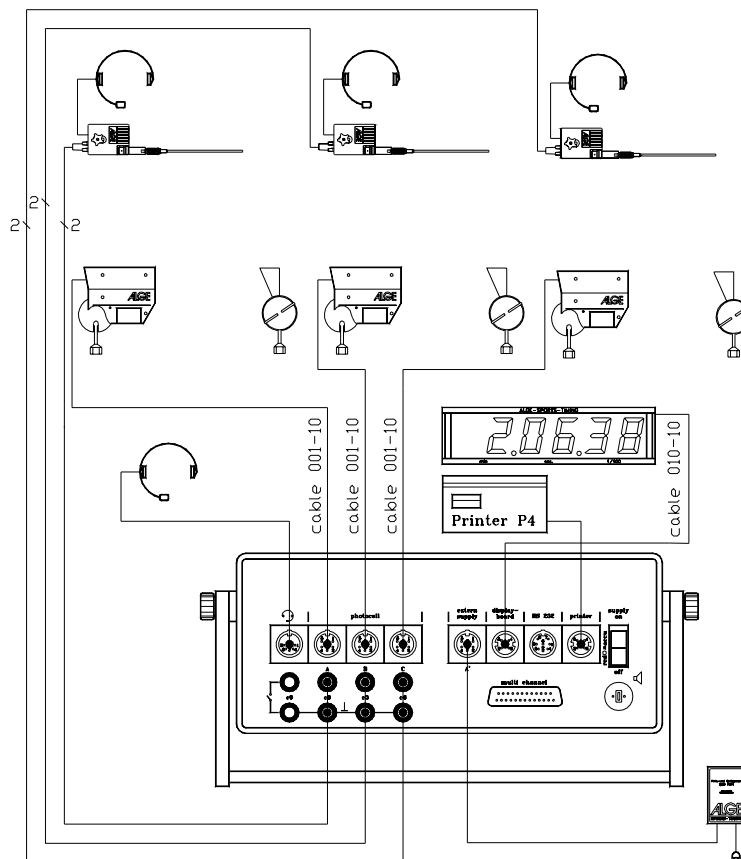

**Choose the program:**

- press toggle switch (8) upwards (position "program+line test")
- turn device on (switch 17)
- release yellow button (6) and toggle switch (8)
- select program 1 with yellow button (6)
- if the display (1) shows "Pr.1" and the version number, press the red and yellow button (6+7) together
- program 3-COURSE-TIMER is ready for timing

**Start:**

You can connect up to three different start impulse devices at the Timer S4 (e.g. ALGE startgate STSc). You can use the green / black banana sockets (19, 20, and 21).

- the start impulse device starts the timer of the connected channel
- you can view the running time of the three courses by switching toggle switch (5)

**Intermediate time:**

There is no intermediate channel. You can receive any amount of stop impulses. You will need to connect your intermediate photocell in parallel with your finish photocell. You will then need to press the yellow button (7) after recording the intermediate time in order to have the running time prior to receiving the finish impulse.

This is an advanced feature that will require adapter 018--5 and practice. It is not recommended for courses under 30 seconds.

**Finish :**

It is important that you connect the start and stop impulse device of each timer on top of each other:

*Course A:* connect startgate at banana socket (19) and photocell on socket (10)

*Course B:* connect startgate at banana socket (20) and photocell on socket (11)

*Course C:* connect startgate at banana socket (21) and photocell on socket (12)

- you can see the running time or finish time by switching toggle switch (5) to the correct position
  - A-timer for course A
  - B-timer for course B
  - C-timer for course C
- in order to reset the time of a course press at the same time red and yellow button (6+7).

**Output of times on display (1) and Printer P4:**

- toggle switch (5) on position "A-timer"
- call all time after time with yellow key (7)
- it shows the running time on the display (1) as soon as the memory is empty
- if timer A was not started it shows "0:00.00" in the display (1)
- toggle switch (5) on position "B-timer"
- call all time after time with yellow key (7)
- it shows the running time on the display (1) as soon as the memory is empty
- if timer B was not started it shows "0:00.00" in the display (1)
- toggle switch (5) on position "C-timer"
- call all time after time with yellow key (7)
- it shows the running time on the display (1) as soon as the memory is empty
- if timer C was not started it shows "0:00.00" in the display (1)

**Reset of clock:**

- choose the clock with toggle switch (5) which you want to reset.
- press the red and yellow button (6+7) at the same time
- the display shows "0:00.00", this clock is ready for the next start

**Pre-adjustment of the options:**

dF-30	finish-delay time = 0.3 seconds
dS-1,0	start-delay time = 1 second
SE AUS	sequential mode is off, split mode is on
LZE AUS	running tenth seconds are off
LF CH1-2	running time for display board interface is on channel 1 and 2
TAU AUS	precision is 1/100 seconds
HUn EIn	precision is 1/100 seconds
Pri 6.0	printer speed for Printer P3
Lr 0	printer prints in every line

**Printer P4:** example of a print output:

PA	0:20.93
PB	0:20.88
PC	0:21.04
PB	0:20.83
PA	0:21.01

- times of course A are marked with PA
- times of course B are marked with PB
- times of course C are marked with PC

**Display board GAZc:**

You can display the net time on a ALGE display board GAZc. The position of toggle switch (5) directs which time is shown on the display board (and display (1)).

*Data channel 1 (running time):* This output is the same as display (1). A finish time stays on the display until you press the yellow button (7). Now it shows the next finish time or the running time.

*Data channel 2 (finish time):* It shows always the last finish time.

*Attention:* You can turn the plug of the display board cable 180°. By turning the plug you switch between running time and finish time, if it is set on LF-CH1 (see page 18, chapter 2.6.5.).

**Computer output through RS 232 interface:**

The interface from Timer S4 to a computer is socket RS 232 (15). Interfacing a computer with a Timer S4 is very easy. Please consult your ALGE agent for information for cables and software.

**Transfer format:** 4800 baud, 1 start bit, 8 ASCII-bit, no parity-bit, 1 stop bit

**Data format:** #####xPAxxHH:MM:SS.zht (CR)

- ##### ..... continuous ID number (4-digits)
- PA ..... identification for course A, B, or C
- HH:MM:SS.zht ..... time in hours, minutes, seconds and thousandths
- x ..... blank
- (CR) ..... carriage return

**Connection for external devices (10, 11, 12 and 13):**

-	<i>Course A:</i>	start	channel 0	banana socket (19)	1 pair cable
		intermediate time	channel 2	Multi Channel (22)	1 pair cable
		finish	channel 1	socket (10)	cable 001
-	<i>Course B:</i>	start	channel 3	banana socket (20)	1 pair cable
		intermediate time	channel 5	Multi Channel (22)	1 pair cable
		finish	channel 4	socket (11)	cable 001
-	<i>Course C:</i>	start	channel 6	banana socket (21)	1 pair cable
		intermediate time	channel 8	Multi Channel (22)	1 pair cable
		finish	channel 7	socket (12)	cable 001

### **3.3. Show-Jumping (program 2):**

For show-jumping exists an separate manual. If you use the Timer S4 for show jumping ask for the show jumping manual at your ALGE dealer.

**The following programs for show jumping are available:**

- standard show jumping
- standard show jumping in two stages
- time show jumping
- two stage show jumping
- standard show jumping with American stage - E
- standard show jumping with American stage - F

### **3.4. 18-CHANNEL-TIMER (program 3):**

Timing of events with one start channel and up to 17 channels for intermediate times and finish time.

#### ***Connection for external devices:***

There are two ways to access the available channels.

Use the Multi-Channel MC18 accessory to allow the input of up to 18 sensors. Connect the the MC18 to the socket (22). Please refer to page 55 chapter 5.1.7. for a detailed plan.

You can also use adapter cables to allow the input of up to 10 channels directly on the back of the S4 (channel 0 to channel 9). This will require the manufacture of special adapter cables. Please refer to page 54 chapter 5.1.1. for a detailed plan.

#### **3.4.1. 18-Channel-Timer with net time:**

Net timing for events with one start impulse and up to 17 channels for intermediate- or finish times.

- Only one competitor on the course or mass start
- The time starts from 0:00.00 after receiving a start impulse.

#### ***Choose the program:***

- press toggle switch (8) upwards (position "program+line test")
- turn device on (switch 17)
- release yellow button (6) and toggle switch (8)
- select program 3 with yellow button (6)
- if the display (1) shows "Pr.3" and the version number, press the red and yellow button (6+7) together
- program is ready for timing

#### ***Start:***

A start impulse starts the clock (banana socket (19); channel 0)

#### ***Finish- or Intermediate time-Impulse:***

You can connect up to 17 impulse devices to make intermediate- or finish time impulses (e.g. photocell RLS1c, Handswitch)

#### ***Reset of the clock:***

- press the red and yellow button (6+7) at the same time
- the display shows now "0:00.00"
- the course is ready for the next competitor

**Pre-adjustment of the options:**

dF-0.2	finish-delay time = 0.2 seconds
dS-1.0	start-delay time = 1 second
SLP 5.0	duration of displaying on display and display board = 5 seconds
LZE EIn	running tenth seconds are off
LF CH1-2	running time for display board interface is on channel 1 and 2
TAU EIN	precision is 1/1000 seconds
HUn AUS	precision is 1/1000 seconds
AUT EIn	display automatic is on
Pri 60.	printer speed for Printer P3
Lr 0	printer prints in every line

**Printer P4:**

	SZ	0:00.000
0001	K11	0:32.323
0002	K3	0:32.495
0003	K10	0:33.023
0004	K17	0:33.385
0005	K1	0:33.502
0006	K6	0:33.897

- all times are printed automatically
- each stop impulse gets a continuous ID number (4-digits)
- SZ means start time
- K and the following number marks the channel time is printed in 1/1000 seconds

**Display board GAZc:**

It is possible to show the net time on a ALGE display board GAZc.

**Data channel 1 (running time):** This output is the same as display (1). A finish time is shown for 7 seconds, before it turns back to the running time. If you have more finish times within a short time it shows every finish time for one second.

**Data channel 2 (finish time):** It shows always the last finish time.

**Attention:** You can turn the plug of the display board cable 180°. By turning the plug you switch between running time and finish time, if it is set on LF-CH1 (see page 18, chapter 2.6.5.)

**Computer output through RS 232 interface:**

The interface from Timer S4 to a computer is socket RS 232 (15). Interfacing a computer with a Timer S4 is very easy. Please consult your ALGE agent for information for cables and software.

**Transfer format:** 4800 baud, 1 start bit, 8 ASCII-bit, no parity-bit, 1 stop bit

**Data format:** #####xK01xHH:MM:SS.zht (CR)

- ##### ..... continuous ID number (4-digits)
- K01 ..... channel number
- HH:MM:SS.zht ..... time in hours, minutes, seconds and thousandths
- x ..... blank
- (CR) ..... carriage return

**3.4.2. 18-Channel-Timer with time of day and net time:**

This mode is the most versatile of all of the available programs. These programs are primarily designed for the advanced user, but are easy to learn. Users of the S3 8K will find that this new program works in a similar way to the old Hour Print program. Computer interface users will be able to take full advantage of the power of the S4 for total time management. This mode was designed to allow the user to have all needed sensors plugged in at one time and to switch between them with software in the PC.

*Ideal applications include:*

Motor and Cycling sports with race time and lap time being recorded simultaneously.  
Bob and Luge, Cross Country Skiing, Alpine Skiing  
Track Cycling, Speed Skating, Inline Skating  
Track and Field, Acceleration test tracks, ETC.

You can either input the real time of day or use 0:00.0 as the time of day. The timer will then allow the simultaneous recording of both running times.

*Channel Assignments:*

channel 1	start channel
channel 2 to 8 and 10 to 17	stop channel
channel 9	Lap time or Time-out

You can set channel 9 (banana socket 18) for lap timing or time-out (see page 18, chapter 2.6.3; pre-adjustment = lap timing).

When using lap timing with channel 9 it stops the net time and starts at the same time from zero (Taylor Sequential Split).

When using time-out with channel 9 it stops the net time. The next impulse from channel 9 starts the net time running again.

You can use this program as well for split/sequential-mode. Input 0:00.00 as time of day. Every impulse from channel 9 (red/black banana jack 18) gives you the total time and lap time (Cumulative and Taylor sequential splits)

**Choose the program:**

- press toggle switch (8) upwards (position "program+line test")
- turn device on (switch 17)
- release yellow button (6) and toggle switch (8)
- select program 3 with yellow button (6)
- if the display (1) shows "Pr.3" and the version number, press the red and yellow button (6+7) together
- after a few seconds the display shows "0:00.00"
- press the red and yellow button (6+7) together
- the display shows "HP 0:00.00"
- input time of day (red button (6) to set hours, yellow button (7) to set minutes)
- start the time of day by pressing toggle switch (8) to lower position (synchronize start) or receive and impulse from the Start socket (19)
- program is ready for timing

**Display:**

- it shows the time of day in the display (1) when toggle switch (5) is on position "A-timer" or "B-timer"
- it shows the net time in the display (1) when toggle switch (5) is on position "C-timer"

**Start:**

A start impulse starts the clock (banana socket (19); channel 0). It prints "SZ" (start time), time of day, and "0:00.00" on the P4 printer.

**Finish- or Intermediate time-Impulse:**

You can connect up to 16 impulse devices to make intermediate- or finish time impulses (e.g. photocell RLS1c, Handswitch). It prints for each impulse the continuous ID number (4-digits), the channel number, time of day, and net time.

**Lap time or Time-out:**

An impulse from channel 9 (banana jack 18) makes a lap time or time-out (depending on set-up of options, see page 18, chapter 2.6.3.)

**Reset of the clock:**

- press the red and yellow button (6+7) at the same time
- the display shows on toggle switch position "C-timer" "0:00.00"
- the course is ready for the next competitor or race

**Pre-adjustment of the options:**

dF-20	finish-delay time = 0.2 seconds
dS-1.0	start-delay time = 1 second
SLP 5.0	duration of displaying on display and display board = 5 seconds
SE nod	lap timing for channel 9 (banana jack 18)
nET AUS	interface "display board" (14) transfers only time of day or net time
LZE EIN	running tenth seconds are off
LF CH1-2	running time for display board interface is on channel 1 and 2
SEC AUS	speed of output for display board interface = 0,1 seconds
TAU EIn	precision is 1/1000 seconds
HUn AUS	precision is 1/1000 seconds
AUT EIn	display automatic is on
Pri 6.0	printer speed for Printer P3
Lr 0	printer prints in every line

**Printer P4:**

	SZ	10:00:00.000
		0:00.000
0001	K11	10:00:32.323
		0:32.323
0002	K3	10:00:32.495
		0:32.495
0003	K10	10:00:33.023
		0:33.023

- time of day from start
- all times are printed automatically
- it prints for every impulse first the time of day and then the net time
- each impulse is printed with a continuous ID number (4-digits)
- SZ means start time (channel 0)
- K means channel, the number following the K is the channel number

**Display board: GAZc:**

You can display the running time (time of day or net time) or run time on the display board GAZc.

Use toggle switch (5) to adjust either time of day or net time. With the data channel you set up the running time or run time.

Position of Toggle Switch (5)	Output: Data Channel 1	Output: Data Channel 2
A-timer	running "time of day"	stopped "time of day"
B-timer	running "time of day"	stopped "count-down time"
C-timer	running "count-down time"	stopped "count-down time"

If you change the option nET AUS to nET EIN it changes automatically the baud rate to 4800 and transfers the time of day and net time.

**Attention:** You must change the Eprom in the GAZc to 4800 baud also.

*Data channel 1 (running time):* This output is the same as display (1). A finish time is shown for 7 seconds, before it turns back to the running time. If you have more finish times within a short time it shows every finish time for one second.

*Data channel 2 (finish time):* It shows always the last finish time.

**Attention:** You can turn the plug of the display board cable 180°. By turning the plug you switch between running time and finish time, if it is set on LF CH1 (see page 18, chapter 2.6.5.).

**Computer output through RS 232 interface:**

The interface from Timer S4 to a computer is socket RS 232 (15).

Interfacing a computer with a Timer S4 is very easy. Please consult your ALGE agent for information for cables and software.

**Transfer format:** 4800 baud, 1 start bit, 8 ASCII-bit, no parity-bit, 1 stop bit

**Data format:**                   ####xK01xHH:MM:SS.zht (CR)  
    xxxxxxxRxHH:MM:SS.zht (CR)

1. Line:

#### ..... contiouous ID number (4 digits)  
 K01 ..... channel number  
 HH:MM:SS.zht ..... time in hours, minutes, seconds and thousandths  
 x ..... blank  
 (CR) ..... carriage return

2. Line:

R or N ..... net time  
 HH:MM:SS.zht ..... net time in hours, minutes, seconds and thousandths  
 x ..... blank  
 (CR) ..... carriage return

impulse from channel 9           R = sequential (lap time)  
    N = Time-out

**3.4.3. 18-Channel-Timer with time of day and count-down:**

This program is ideal for timing games such as Volleyball, Hockey, Football, Basketball, or any other sports with period of play. You have the option of using the Time Out feature as well. This can also be used for timed Cycling events or as a Concentration timer for Track and Field..

Set-up like program 3.3.2. "18-Channel-Timer with time of day and net time". It is possible to have the time a time of day and a count-down. In this program you can use 18 channels for timing.

channel 1	start channel
channel 2 to 8 and 10 to 17	count-down channel
channel 9	count-down with reset and start at the same time or count-down with time-out

You can set channel 9 (banana socket 18) for count-down with reset and start at the same time, or count-down with time-out . (default setting is count-down with reset and start at the same time).

#### **Choose the program:**

- press toggle switch (8) upwards (position "program+line test")
- turn device on (switch 17)
- release yellow button (6) and toggle switch (8)
- select program 3 with yellow button (6)
- if the display (1) shows "Pr.3" and the version number, press the red and yellow button (6+7) together
- after a few seconds the display shows "0:00.00"
- press the red and yellow button (6+7) together
- the display shows "HP 0:00.00"
- input time of day (red button (6) to set hours, yellow button (7) to set minutes)
- start the time of day by pressing toggle switch (8) to lower position (synchronize start)
- display (1) shows now a running time
- press toggle switch (8) downwards (position "delay time")
- press toggle switch (8) downwards as many times as needed until display (1) shows "SE nod" (TO nod possibly if you chose Time out before)
- press toggle switch (8) upwards (position "program+line test")
- display now shows "SE nodC". "C" means that the "count-down with reset and start at the original input time" program is now active
- if you want to choose the program "count-down with time-out" press the yellow button (7). The display (1) will now show "TO nodC"
- press red and yellow button (6+7) together
- switch toggle switch (5) on position "C-timer"
- display (1) shows "0:00.00"
- press red and yellow button (6+7) together
- display (1) shows "0.00"
- input count-down time (red button (6) = minutes, yellow button (7) = seconds)
- Timer S4 is ready for timing. You can start the count-down with a start impulse (channel 0, banana jack 19)

#### **Display:**

- it shows the time of day in the display (1), when toggle switch (5) is on position "A-timer" or "B-timer"
- it shows the count-down in the display (1), when toggle switch (5) is on position "C-timer"

#### **Start:**

A start impulse starts the clock (banana socket (19); channel 0). It prints "SZ" (start time), time of day, and count-down time.

***Finish- or Intermediate time-Impulse:***

You can connect up to 16 impulse devices to make intermediate- or finish time impulses (e.g. photocell RLS1c, Handswitch). It prints for each impulse the continuous number (4-digits), the channel number, time of day, and count-down.

***Reset and start at the same time or time-out:***

An impulse from channel 9 (banana jack 18) makes a reset and start at the same time, or time-out (depending on set-up of options, see page 18, chapter 2.6.3.)

***Reset of the clock:***

- press the red and yellow button (6+7) at the same time
- the display shows on toggle switch position "C-timer" the pre-adjusted count-down time. On toggle switch position "A-timer" it still shows the time of day
- the course is ready for the next competitor

***Run down of Count-down:***

- at the end of the count-down the horn honks (socket 24)
- after 5 seconds it shows the pre-adjusted count-down time on the display again
- the Timer S4 is ready to start the next count-down

***Pre-adjustment of the options:***

dF-20	finish-delay time = 0.2 seconds
dS-1.0	start-delay time = 1 second
SLP 5.0	duration of displaying on display and display board = 5 seconds
<b>SE nodC</b> or <b>TO nodC</b>	you have to change to one of this adjustments (see page 18, chapter 2.6.3.)
nET AUS	interface "display board" (14) transfers only time of day or net time
LZE = EIn	running tenth seconds are off
LF CH1-2	running time for display board interface is on channel 1 and 2
TAU EIn	precision is 1/1000 seconds
HUn AUS	precision is 1/1000 seconds
AUT EIn	display automatic is on
Pri 6.0	printer speed for Printer P3
Lr 0	printer prints in every line

***Printer P4:***

	SZ	10:00:00.000	
		0:00:00.000	
0001	SZ	10:05:03.481	
		1:00.000	
0001	K11	10:00:32.323	
		0:32.323	
0002	K3	10:00:32.495	
		0:32.495	
0003	K10	10:00:33.023	
		0:15.023	

- adjusted time of day
- adjust the count-down time
- time of day of count-down start
- count-down time
- for each impulse it prints first the time of day and then the count-down time
- each impulse has a continuous ID number (4 digits)
- SZ means start time (channel 0)
- K means channel, after the K it prints the channel number
- all times are printed automatically

**Display board: GAZc:**

You can display the running time (time of day or count-down) or run time on the display board GAZc. Use toggle switch (5) to adjust either time of day or count-down time. With the data channel you set up the running time or run time.

Position of Toggle Switch (5)	Output: Data Channel 1	Output: Data Channel 2
A-timer	running "time of day"	stopped "time of day"
B-timer	running "time of day"	stopped "count-down time"
C-timer	running "count-down time"	stopped "count-down time"

If you change the option nET AUS to nET EIN it changes automatically the baud rate to 4800 and transfers the time of day and net time. You must change the Eprom in the GAZc to 4800 baud also.

**Data channel 1 (running time):** This output is the same as display (1). A finish time is shown for 7 seconds, before it turns back to the running time. If you have more finish times within a short time it shows every finish time for one second.

**Data channel 2 (finish time):** It shows always the last finish time.

**Attention:** You can turn the plug of the display board cable 180°. By turning the plug you switch between running time and finish time, if it is set on LF CH1 (see page 18, chapter 2.6.5.).

**Computer output through RS 232 interface:**

The interface from Timer S4 to a computer is socket RS 232 (15). Interfacing a computer with a Timer S4 is very easy. Please consult your ALGE agent for information for cables and software.

**Transfer format:** 4800 baud, 1 start bit, 8 ASCII-bit, no parity-bit, 1 stop bit

**Data format:** #####xK01xHH:MM:SS.zht (CR)  
 xxxxxxxRxHH:MM:SS.zht (CR)

<u>1st Line:</u>	<u>2nd Line:</u>
##### ..... continuous ID number	R or N ..... identification net time
K01 ..... channel number	HH:MM:SS.zht ..... net time
HH:MM:SS.zht ..... time of day	x ..... blank
x ..... blank	(CR) ..... carriage return
(CR) ..... carriage return	
impulse from channel 9	R = sequential (lap time)
	N = Time-out

### 3.5. Parallelslalom (Program 4):

There are two ways to measure the time in the program Parallelslalom.

- Parallelslalom with finish-difference timing
- Parallelslalom with finish-difference timing and net timing

#### 3.5.1. Parallelslalom with Finish-Difference Timing:

For this timing you need two photocells in the finish. All you measure is the difference time between the two competitors on the course. As soon as the first competitor reaches the finish the timer starts. The clock stops, when the second competitor reaches the finish. A "b" on the display means that the blue course won, a "r" that the red course won.

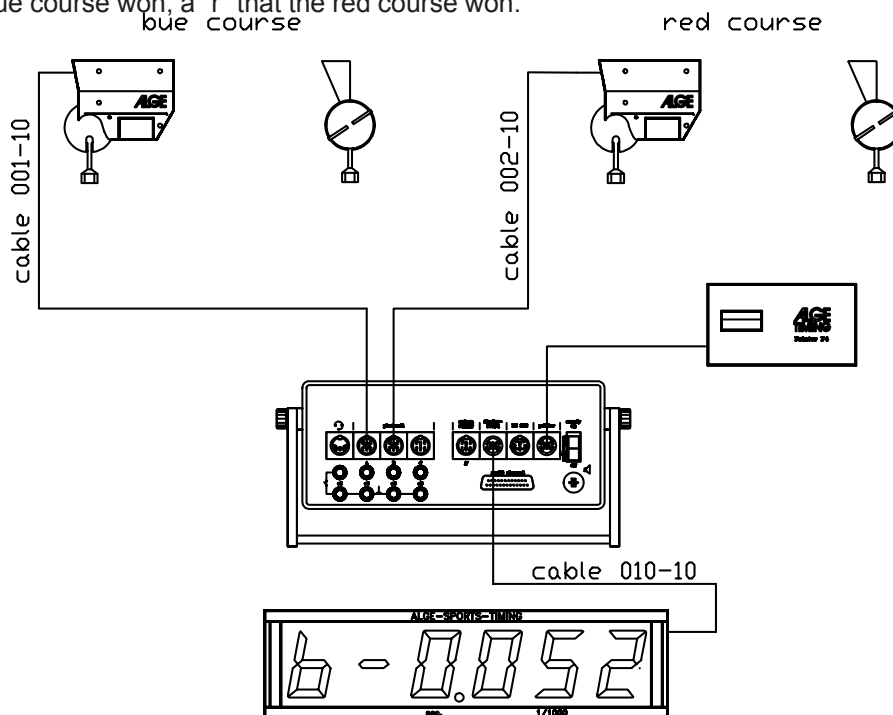

#### Choose the program:

- switch the toggle switch (5) upwards on position "A-timer" or "B-timer"
- press toggle switch (8) upwards (position program+line test) and hold it
- turn the device on (17)
- release toggle switch (8)
- select program 4 with yellow button (7)
- if the display shows "Pr.4" and the version number, press the red and yellow button (6+7) together
- the parallel-slalom program (finish-difference time measurement) is ready for timing

#### Start:

There is no start impulse for this timing, since you measure only the difference time in the finish.

**Finish:**

You need two photocells in the finish. The photocell of the red course needs the cable 002-10 (green cable), the photocell of the blue course the cable 001-10 (red cable).

*Red course:* photocell cable 002-10, 002-20, or 002-30 (green cable)

*Blue course:* photocell cable 001-10, 001-20, or 001-30 (red cable)

**Reset of the clock:**

After each timing you have to set the clock on "P 0:00.00" by pressing the red and yellow button (6+7) at the same time. Before you reset the clock, you cannot measure a new time.

- press red and yellow button (6+7) at the same time
- display (1) shows "P 0:00.00"
- timer is ready for next race

**Pre-adjustment of the options:**

LF CH1-2	running time for display board interface is on channel 1 and 2
TAU EInd	precision is 1/1000 second (1/1000 is shown on display (1))
HUn EIN	no function, since precision is already adjusted with 1/1000
Pri 6.0	printer speed for Printer P3
Lr 0	printer prints in every line

**Printer P4:** example of a print output:

b- 0.034	blue course is 0,034 seconds ahead
r- 0.324	red course is 0,324 seconds ahead
b- 0.012	blue course is 0,012 seconds ahead
b- 1.347	blue course is 1,347 seconds ahead
r- 0.239	red course is 0,239 seconds ahead

**Display Board GAZc:**

The display board (6 figures) shows the time in 1/1000 seconds as well as the course that wins (r = red, b = blue). The 1/1000 are shown with the standard adjustment of the display board (thumb wheel switch on position 0 and shift switch on middle position).

If you want to show only the 1/100 on the GAZc, then switch the thumb wheel switch on position 13, and the shift to the lower position.

**Data channel 1 (running time):** Show always the same time as display (1). A time which is stopped is shown until red and yellow button is pressed at the same time. On the display is also the running 1/10 second shown (for Videogenerator). If you do not want to display the running 1/10 switch to data channel two (see page 18, chapter 2.6.5).

**Data channel 2 (finish time):** The last finish difference time is shown (no running time).

**Attention:** You can turn the plug of the display board cable 180°. By turning the plug you switch between running time and finish time, if it is set on "LF CH1" (see page 18, chapter 2.6.5).

**Computer output through RS 232 interface:**

The interface from the Timer S4 to a computer is the socket RS 232 (15). Interfacing a computer with a Timer S4 is very easy. Please consult your ALGE agent for information for cables and software.

**Transfer format:** 4800 baud, 1 start bit, 8 ASCII-bit, no parity-bit, 1 stop bit

**Data format:** #####xPRxxHH:MM:SS.zht (CR)  
 ##### ..... continuous ID number (4-digits)  
 PR ..... identification for winning course  
           PR ..... red course      PB ..... blue course  
 HH:MM:SS.zht ..... time in hours, minutes, seconds and thousandths  
 x ..... blank  
 (CR) ..... carriage return

**Connection for external devices (10, 11, 12 and 13):**

- socket A (10), B (11), C (12), and A' (13) are all identical

**3.5.2. Parallel Slalom with finish-difference time and net time:**

For this kind of measurement you need a starting device (startgun with startmicrophone, start machine, etc.) and two photocells for the finish. It measures the run time of both competitors, as well as the finish-difference time. The finish-difference time is shown with indication of the winner (b = blue course, r = red course).

This program is usable for parallel slalom and pursuit bicycle races.

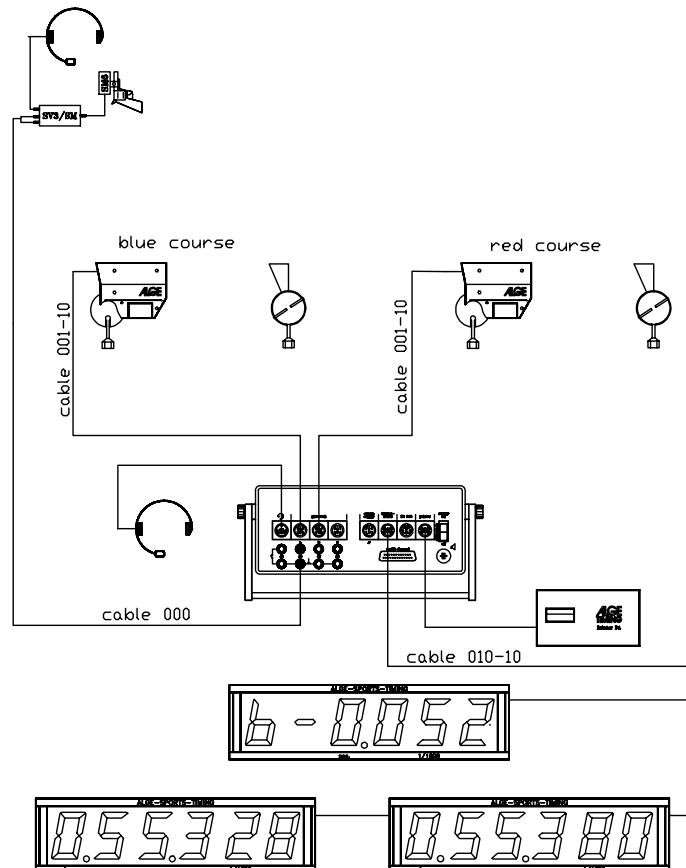

**Choose the program:**

- switch the toggle switch (5) upwards on position "C-timer"
- press toggle switch (8) upwards (position program+line test) and hold it
- turn the device on (17)
- release toggle switch (8)
- select program 4 with yellow button (7)
- if the display shows "Pr.4" and the version number, press the red and yellow button (6+7) together
- the parallel-slalom program (finish-difference time measurement) is ready for timing

**Start:**

The start impulse starts the running time for the red and blue course.

Cable: two core cable from the start, connection on the timer is banana-socket (19) (channel 1)

**Finish:**

Two photocells are necessary for the finish. You have to connect the photocell of the red course (use cable 001) with socket (10), the photocell of the blue course (use cable 001) with socket (11).

red course: photocell cable 001-10, 001-20, or 001-30 (red cable) connected at socket (10)

blue course: photocell cable 001-10, 001-20, or 001-30 (red cable) connected at socket (11)

- If the toggle switch (5) is on position "A-timer", it shows the running time of the red course in the display (1) and on the display board
- If the toggle switch (5) is on position "B-timer", it shows the running time of the blue course in the display (1) and on the display board
- If the toggle switch (5) is on position "C-timer", it shows the finish-difference time in the display (1) and on the display board (until the first competitor reaches the finish it shows "P 0.000")

**Reset of the clock:**

After each timing measurement you have to reset the clock. Without a reset you cannot start the next competitors.

- press the red and yellow button (6+7) at the same time
- display (1) shows "P 0:000"
- Timer S4 is ready for the next measurement

**Pre-adjustment of the options:**

dF-20	finish-delay time = 0.2 seconds
dS-1.0	start-delay time = 1 second
LZE EIn	running tenth seconds are off
LF CH1-2	running time for display board interface is on channel 1 and 2
TAU EIn	precision is 1/1000 seconds, display (1) shows 1/1000 seconds
HUn AUS	precision is 1/1000 seconds
Pri 6.0	printer speed for Printer P3
Lr 0	printer prints in every line

**Printer P4:**

Pb	0.58.862	run time of the blue course
Pr	0.58.871	run time of the red course
Pb-	0.009	blue course wins with a lead of 0.009 seconds

**Display board GAZc:**

It shows the time in 1/100 seconds on the display board. The 1/1000 seconds are shown on the display board, when the thumb wheel switch is on position 13 and the shift switch on middle position. This adjustments must be made on the display board. To show the 1/1000 seconds you need a board with 6 digits.

With the toggle switch (5) you can select the different times:

- A-timer = run time of red course
- B-timer = run time of blue course
- C-timer = finish-difference time with identification

Data channel 1 (running time): It shows the running time that is selected with toggle switch (5).  
 Data channel 2 (run time): It is not possible to switch to the run time (data channel 2 is not possible).

*Using three display boards:*

If you want to show each time on a separate display board you have to output the date with a address through interface "display board" (14). On page 18 it tells you how you activate the address.

- run time of red course      thumb wheel switch of display board on position 1
- run time of blue course    thumb wheel switch of display board on position 2
- finish-difference time      thumb wheel switch of display board on position 3

**Computer output through RS 232 interface:**

The interface from the Timer S4 to a computer is the socket RS 232 (15). Interfacing a computer with a Timer S4 is very easy. Please consult your ALGE agent for information for cables and software.

**Transfer format:** 4800 baud, 1 start bit, 8 ASCII-bit, no parity-bit, 1 stop bit

**Data format:** #####xPRxxHH:MM:SS.zht (CR)  
 ##### ..... continuous ID number (4-digits)  
 PR ..... identification for course  
           PR ..... red course           PB ..... blue course  
 HH:MM:SS.zht ..... run time in hours, minutes, seconds and thousandths  
 x ..... blank  
 (CR) ..... carriage return

**Connection for external devices (10, 11, 12 and 13):**

- banana socket (19) for start impulse
- socket A (10) for impulse from red course
- socket B (11) for impulse from blue course

### 3.6. SPEED (program 5):

You can only measure the speed in one direction. You can display the speed in km/h, m/s or mph

toggle switch (5)	display	printer	display board	
			channel 1	channel 2
A-timer:	km/h	km/h and mph	km/h	mph
B-timer:	mph	km/h and mph	km/h	mph
C-timer:	m/s	km/h and m/s	km/h	m/s

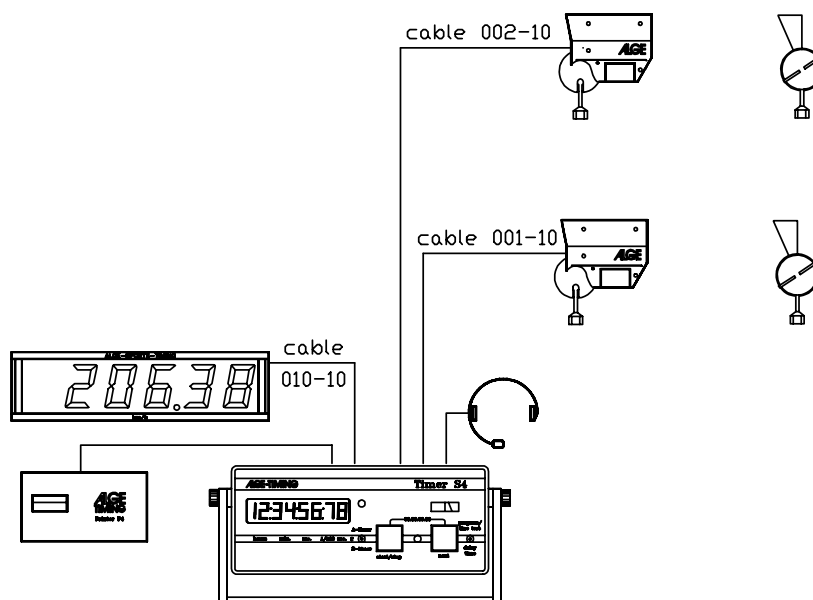

#### Measuring distance:

You must input the measuring distance in whole Meters.  
The measuring distance can be between 1 and 180 m.

- di. 10 distance = 10 m (default distance, or the last distance input when using this program)
- Increase distance 1 m with yellow button (7)
- Increase distance 10 m with red button (6)

**Attention:** In order to get exact measuring results it is important to adjust the distance of the photocells exactly. Please invest in a quality 100 meter tape measure.

#### Impulse devices:

Photocells are mostly used as impulse devices for speed measurement. The first photocell is connected with start cable 002, the second with stop cable 001.

### Measuring time:

The measuring time is the time between the 1st and 2nd impulse. The measuring time is adjusted automatically by selecting the measuring distance. The measuring time is chosen in order to measure the lowest speed with 4.3 km/h. If you want to measure a very low speed you have to do the following adjustment:

	lowest Speed	measuring time for 10 m measuring distance	adjustment of variables
<b>short measuring time</b>	about 43 km/h	about 1 second	SLP 0.0H
<b>standard measuring time</b>	about 4,3 km/h	about 10 second	SLP 0.0

- display (1) shows SP 00.00
- press toggle switch (8) to lower position
- display (1) shows di and adjusted distance
- press toggle switch (8) to lower position
- display (1) shows SLP 0.0
- if you press toggle switch (8) upwards it shows in the display (1) "SLP 0.0H" (long measuring duration)
- if you press toggle switch (8) again upwards it shows in the display (1) "SLP 0.0L" (short measuring duration)
- as soon as it shows the correct measuring duration in the display press the red and yellow button (6+7) at the same time

### Adjustment of Options:

Press red and yellow button (6 +7) together.

SLP should be set on 0, if you have measurements within a short time.

If you set SLP = 0 it keeps the result of each measurement on the display board until the next measurement is done.

### Pre-adjustment of the options:

di. 10	measuring distance = 10 Meter
SLP 0.0	display board shows the speed until the next result comes
HUN EIn	measurement accuracy 1/100 km/h
Pri 60	printer speed for Printer P3
Lr 0	printer prints in every line

### Printer P4:

The Printer P4 prints the speed in km/h and mph or m/s. If it prints mph or m/s depends on the position of toggle switch (5).

example of print output:

93.52km/h	58.12mPh
87.94km/h	54.66mPh
116.32km/h	72.29mPh

Speed is printed in km/h and mph. The toggle switch (5) is on position "A-timer" or "B-timer"



### **3.7. SWIMMING (program 6):**

This program is dependent on the number of impulses received from the touchpads ( hand switches) to correctly display and print the final time. You must know the number of impulses (touches) that you have to have prior to each event. You must read the Swimming System manual for precise details.

#### **Timing for swimming:**

- max. 8 lanes
- start through a loud speaker (start acoustic SA1)
- stop impulse from touch pad TP1 and (or) handswitches
- switch board (S4-SWIM) to activate the touch pads
- impulse counter for touch pad control
- interface to control up to 8 display boards

#### **Function of the swimming program:**

- o press toggle switch (8) upwards (position "program+line test")
- o turn the Timer S4 on (17)
- o release toggle switch (8)
- o select program 6 with yellow button
- o the display (1) must show "Pr.6" and the software version
- o press red and yellow button (6+7) together
- o wait until the display (1) shows "A00"
- o turn toggle switch (5) to position A-timer or B-timer when using a display board for each lane, C-timer when using one display board for all lanes.
- o input number of impulses at touch pad per lane (1 to 99; with red button (6) by tens. with yellow button (7) by ones.
- o press red and yellow button (6+7) together to store the amount of impulses
- o input the event number (1 to 99; with red button (6) by tens. with yellow button (7) by ones.
- o press red and yellow button (6+7) together to store the event number
- o input the heat number (1 to 99; with red button (6) by tens. with yellow button (7) by ones.
- o press red and yellow button (6+7) together to store the heat number
- o input finish delay time (d = 10 to 99 seconds; with red button (6) by ten seconds. with yellow button (7) by one second.. The delay time is the time after an impulse during which the touch pad is inactive.
- o press red and yellow button (6+7) together to store the amount of impulses
- o Timer S4 is ready for timing
- o if you receive a start impulse it starts the clock
- o the Printer P4 prints every stop impulse from the touch pad as they occur
- o As soon as all swimmers reach the maximum amount of touches, it prints the ranking of the run times, the manual times, and the finish times sorted by lanes
- o you can override the automatic feature by pressing the red button (6) in the event of a dnf.
- o As soon as all results are printed, you can reset the timer by pressing the red and yellow button (6+7) together. The heat number increases automatically by 1.
- o if you want to change the amount of impulses, event number or delay time press again the red and yellow button (6+7) together

Please ask your ALGE representative for a manual of the swimming system!

### **3.8. AUTOMATIC (program 7):**

This program is ideal for training in Skiing, Track Cycling, Swimming, etc. You can also use this program for a simple self timer for skiing.

The automatic mode is used for races with only one competitor on the course. Using the automatic program you have to input the amount of stop impulses per competitor. If a competitor goes through the course and receives all impulses it resets the timer automatically to zero. The next competitor is able to start.

If you use this mode with a printer or display board it is possible to do the timing without operating the device.

You can use the Automatic program as well for the speed measurement at speed skiing. The speed measurement is active (photocell distance = 100 m) when setting one impulse, precision of 1/1000 seconds, and the display shows 1/1000 seconds. The speed is shown on the printer in km/h and m.p.h.

#### ***Choose the program:***

- press toggle switch (8) upwards (position "program+line test")
- turn device on (switch 17)
- release yellow button (6) and toggle switch (8)
- select program 7 with yellow button (6)
- if the display (1) shows "Pr.7" and the version number, press the red and yellow button (6+7) together
- the display (1) shows "2 - - - -"
- input number of impulses per competitor  
e.g. 2 intermediate times + 1 finish time = 3 stop impulses  
pre-adjusted are 2 stop impulse  
with red button (6) increase by tens, increase by ones with yellow button (7)
- press red and yellow button (6+7) together to store the set amount of stop impulses
- display shows amount of stop impulses and "0:00.00"
- timer is ready for timing

#### ***Start:***

- a start is only possible by using channel 0 (banana jack 19 or DIN jack 10 or 13)
- only one competitor is allowed on the course

**Stop:** all 18 channels are available for stop impulses

#### ***Reset of the clock:***

- automatic reset to zero after the last stop impulse
- if a competitor does not reach the finish (or does not activate all stop impulses) you have to reset the clock manual (press twice the red and yellow button (6+7) together).
- you could also parallel a handswitch with the stop sensor and trigger it manually in order to give the correct number of impulses.

#### ***Hint:***

The display time of the last impulse is 10 times longer than the others.

**Pre-adjustment of the options:**

dF-20	finish-delay time = 0.2 seconds
dS-1.0	start-delay time = 1 second
SLP 5.0	display duration on display board = 5 seconds
LZE EIn	running tenth seconds are on
LF CH1-2	running time for display board interface is on channel 1 and 2
TAU EIn	precision is 1/1000 seconds
HUN AUS	precision is 1/1000 seconds
Pri 6.0	printer speed for Printer P3
Lr 0	printer prints in every line

**Printer P4:**

SZ	0 : 00 . 000
0001 K1	0 : 10 . 345
0002 K2	0 : 19 . 479
0003 K3	0 : 29 . 013
SZ	0 : 00 . 00

- all times are printed automatically
- each stop impulse receives a continuous ID number (4 digits)
- the continuous ID number starts for each run with 0001
- after the last stop impulse there is an automatic reset of the time

**Display board GAZc:**

The net time is shown on the ALGE display board.

**Data channel 1 (running time):** A finish time is shown for 7 seconds, before it turns back to the running time. If you have more finish times within a short time it shows every finish time for one second. The output is the same as display (1). A finish time stays on the display until you press the yellow button (7). Now it shows the next finish time or the running time.

**Data channel 2 (finish time):** It shows always the last finish time (and the speed)

**Attention:** You can turn the plug of the display board cable 180°. By turning the plug you switch between running time and finish time, if it is set on LF-CH1 (see page 18, chapter 2.6.5.)

**Computer output through RS 232 interface:**

The interface from Timer S4 to a computer is socket RS 232 (15). Interfacing a computer with a Timer S4 is very easy. Please consult your ALGE agent for information for cables and software.

**Transfer format:** 4800 baud, 1 start bit, 8 ASCII-bit, no parity-bit, 1 stop bit

**Data format:** #####xKYYxHH:MM:SS.zht (CR)

- #### ..... continuous ID number (4 digits)
- KYY ..... identification of channel (K1 to K17)
- HH:MM:SS.zht ..... time in hours, minutes, seconds and thousandths
- x ..... blank
- (CR) ..... carriage return

## 4. DEVICES USED WITH THE TIMER S4

### 4.1. Printer P4:

Electrosensitive printer that connects to the Timer S4 (socket "printer 16"). The Printer P4 is powered by the Timer S4.

**Attention:** you must use NiCad batteries in the Timer S4.

#### o Paper Check:

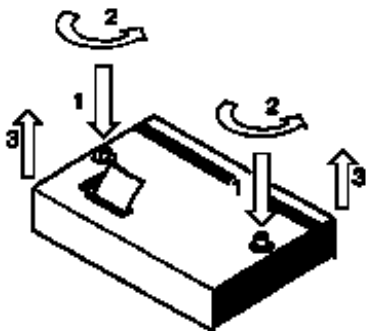

- Push the two cover release buttons down so that they jump up. Remove the cover.
- If you have enough paper, put the cover back and press the two buttons down until they stay in the lower position.

**Attention:** Make sure that the paper comes out through the slotted hole in the cover! Make sure the paper bow spring is folded back.

#### o Changing the paper:

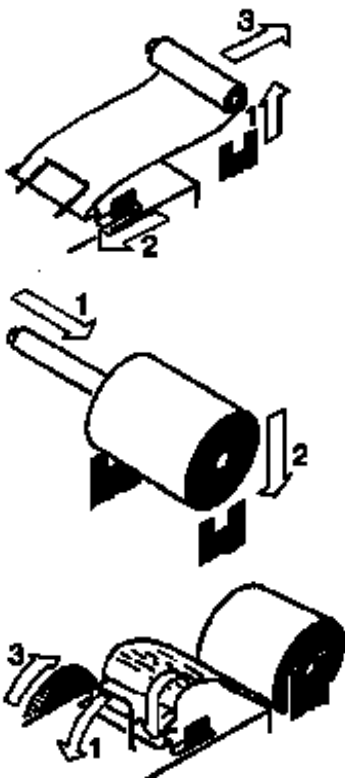

- Remove the rest of the paper from the holder.
- Press the black lever forward and pull the paper out.
- Put the axle into the new paper roll.
- Put the new roll on the paper holder.
- Move paperbow spring into the backward position.
- Insert the beginning of the paper into the paper feed of the printer. Make sure it is cleanly cut.
- Turn the paper advance wheel towards the rear until the paper comes out.
- If necessary correct the paper path through pressing the black lever forward and adjusting the paper manually.
- Put the cover back and press the two buttons until they stay in the lower position.

**Clearing Jammed Paper:**

- Press the black lever forward and pull back the remaining paper.
- Remove the serrated cutter by holding the black lever forward and sliding the cutter towards the lever and lifting upwards.
- Pull the printhead back with your fingernail and remove any stuck paper with tweezers or small needlenose pliers.
- If the paper has jammed under the roller it will be necessary to remove it by sliding a piece of 35mm film through the paper path and rocking it to and fro until the stuck paper is expelled. Use a piece of film about 20 cm long to have something to hold onto.

The printer is a very rugged device but needs regular maintenance for a long service life. Call your ALGE agent if you have further questions.

**Printer-Paper:**

Electrosensitive paper 60 mm width, 40 mm diameter with about 25 m paper length (about 6000 lines). The electrosensitive paper is available at your ALGE representative.

A black strip will become visible on the edge of paper, when a paper roll is about to run out.

*Attention:* Do not pull on the paper when printing. Press the black lever forward and pull the paper carefully out, if the paper is repressed.

The printer-paper has to stay dry!

**4.2. Multichannel MC18:**

The MC18 is used for the 18-Channel-Timer. The MC18 has all 18 channels on banana jacks. Plug the MC18 on the outlet "Multichannel" (22) at the backside of the Timer S4.

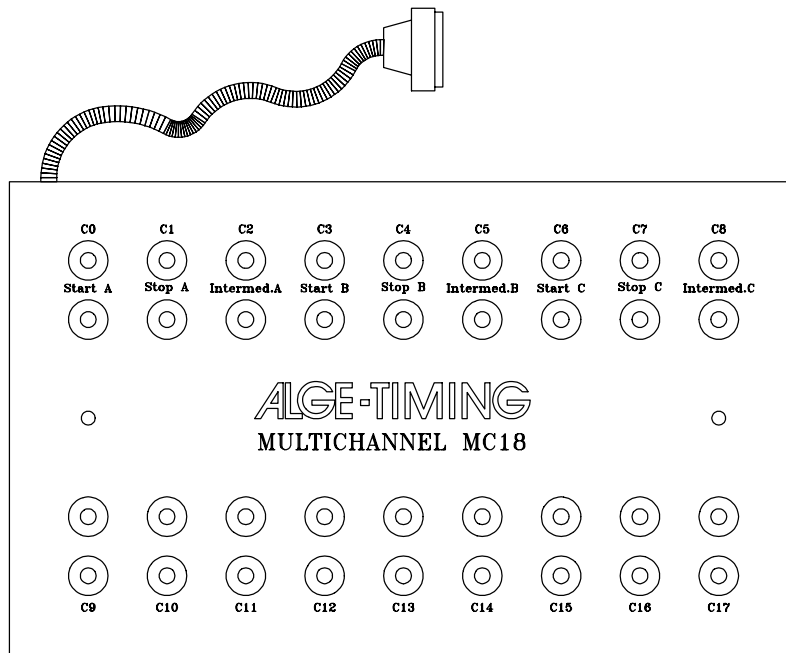

Channel	18-Channel-Timer	3-Course-Timer	Channel	18-Channel-Timer	3-Course-Timer
C0	start	start A	C9	stop 9	no function
C1	stop 1	stop A	C10	stop 10	no function
C2	stop 2	intermediate time A	C11	stop 11	no function
C3	stop 3	start B	C12	stop 12	no function
C4	stop 4	stop B	C13	stop 13	no function
C5	stop 5	intermediate time B	C14	stop 14	no function
C6	stop 6	start C	C15	stop 15	no function
C7	stop 7	stop C	C16	stop 16	no function
C8	stop 8	intermediate time C	C17	stop 17	no function

## **5. TECHNICAL DATA**

<u>Measuring range:</u>	23 hours, 59 minutes, 59.999 seconds
<u>Crystal frequency:</u>	TCXO 9.216 MHz (Temperature compensated Crystal Oscillator)
<u>Accuracy:</u>	
at changeable temperature:	+/- 2,5 ppm at -30 to +75°C (+/-0,009 sec/h)
Aging:	+/- 1 ppm per year
Frequency adjustment:	+/- 0,1 ppm at +25°C
<u>Operative timing range:</u>	-25 to 50°C
<u>Memory:</u>	8000 times with continuous ID number; memory is unaffected when device is turned off due to built in batteries.
<u>Display:</u>	Liquid Crystal Display, 8 digits, figure height 12,7 mm
<u>Electronic:</u>	the most advanced CMOS technology
<u>Power consumption:</u>	without external devices, from internal battery: about 60 mA per hour without external devices.
<u>Impulse channels:</u>	input resistance 10 k $\Omega$ / +5V triggering with < 1V (falling flank) hysteresis about 2 V
<u>Output 5VDC stabilized:</u>	total max of 120 mA
<u>Speech Amplifier:</u>	communication through channel C0, C1, C2, C3, C6, and C9
<u>Loud Speaker:</u>	for 8 $\Omega$ loud speaker, $U_{\max} = 24 V_{pp}$
<u>Operating elements:</u>	1 on/off switch (17) 1 red button "start/stop" (6) 1 yellow button "next" (7) 1 toggle switch "A-, B- and, C-timer" (5) 1 toggle switch "program+line test, delay time" (8)
<u>Casing:</u>	anodized aluminium case L x W x H = 226 x 162 x 95
<u>Weight:</u>	2.2 kg (with batteries)

### 5.1. Connection System:

#### 5.1.1 Photocell jacks and external supply:

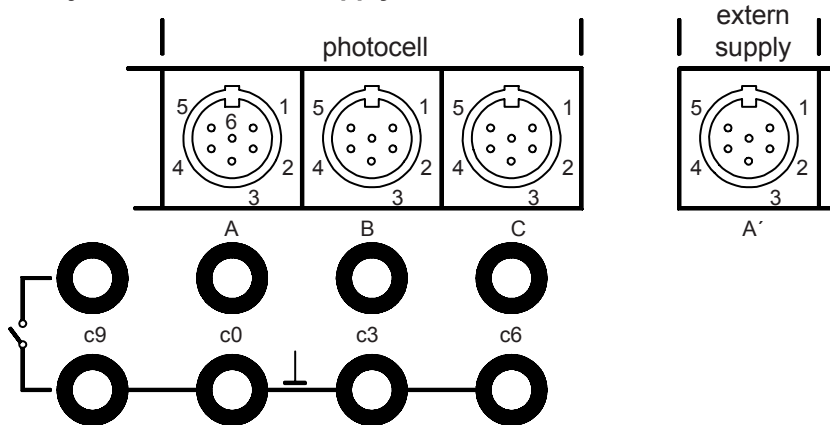

#### Jack A and A' (10 and 13):

- 1 input channel 0 (start)
- 2 input channel 1 (stop)
- 3 common ground
- 4 input external supply (6 to 15 Volt)
- 5 output +5 VDC stabilized
- 6 input channel 2 (intermediate time)

#### Jack B (11):

- 1 input channel 3 (start)
- 2 input channel 4 (stop)
- 3 common ground
- 4 input external supply (6 to 15 Volt)
- 5 output +5 VDC stabilized
- 6 input channel 5 (intermediate time)

#### Jack C (12):

- 1 input channel 6 (start)
- 2 input channel 7 (stop)
- 3 common ground
- 4 input external supply (6 to 15 Volt)
- 5 output +5 VDC stabilized
- 6 input channel 8 (intermediate time)

#### 5.1.2. Headset Jack Q34 (9):

- 1 microphone of headset
- 2 common ground
- 3 loud speaker of headset
- 4 empty
- 5 empty

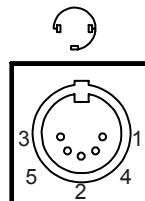

#### 5.1.3. Loud Speaker Jack (24):

- 1 speaker signal
- 2 common ground

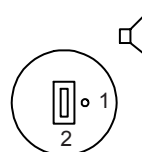

**5.1.4. Display Board Jack (14):**

- 1 common ground
- 2 output supply (6 to 15 VDC)
- 3 output data channel 1
- 4 output supply (6 to 15 VDC)
- 5 output data channel 2

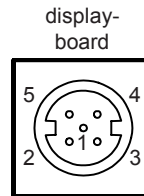

**5.1.5. Printer Jack (16):**

- 1 common ground
- 2 output supply (6 to 15 VDC)
- 3 output data channel 1
- 4 output supply (6 to 15 VDC)
- 5 output data channel 2

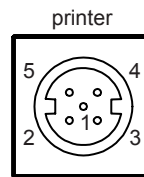

**5.1.6. RS 232c - Computer Jack (15):**

- 1 data TXD
- 2 common ground
- 3 data RXD
- 4 CTS
- 5 RTS
- 6 empty
- 7 output external supply (6 to 15 VDC)
- 8 empty

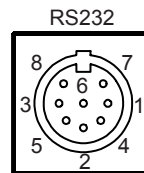

**5.1.7. Multi Channel Outlet (22):**

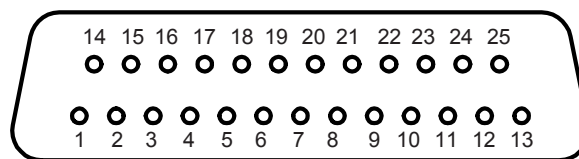

- |   |   |
|---|---|
| 1 channel 9                                 | 12 common ground                            |
| 2 channel 0 (start)                         | 13 output +5 VDC stabilized                 |
| 3 channel 2                                 | 14 channel 1                                |
| 4 channel 3                                 | 15 channel 5                                |
| 5 channel 7                                 | 16 channel 8                                |
| 6 output data (Printer or Displaychannel 2) | 17 channel 6                                |
| Depending on internal jumpersetting         | 18 channel 4                                |
| 7 channel 10 (I/O 0)                        | 19 channel 11 (I/O 1)                       |
| 8 channel 12 (I/O 2)                        | 20 channel 13 (I/O 3)                       |
| 9 channel 15 (I/O 5)                        | 21 channel 16 (I/O 6)                       |
| 10 channel 17 (I/O 7)                       | 22 channel 14 (I/O 4)                       |
| 11 data RXD (RS232)                         | 23 output external supply (5,3 to 14,3 VDC) |
|   | 24 common ground                            |

25 external supply (6 to 15 VDC)

## 5.2. Computer connection - RS 232c interface (15):

Transferformat: 1 start bit, 8 ASCII bit, no parity bit, 1 stop bit  
 Transfer speed: pre adjustment 4800 Baud  
 Pin arrangement of jack: see page 55

You can send control codes form a PC through the RS 232 interface to the Timer S4. You have to send the control codes and finish them with carriage return.

Control Code	Interface	Effect
80(Hex)	Display Board (14), Display (1)	1/10 second on or off of the running time
81(Hex)	Display Board (14), Printer (16), and Display (1)	1/1000 seconds on or off (precision)
82(Hex)	Start delay time	input start delay time (in ASCII, two figures; sec, 1/10)
83(Hex)	Finish delay time	input finish delay time (in ASCII, two figures; sce, 1/10)
84(Hex)	RS232 (15)	output of memory blocks (in ASCII, 2 x 4 figures)
85(Hex)	RS232 (15)	output of memory
86(Hex)	Display (1)	1/1000 seconds shown on display (1)
87(Hex)	Prog.3 special	special adjustment for program 3 (see page 59)
88(Hex)	RS232 (15)	9600 Baud
89(Hex)	RS232 (15)	4800 Baud
8A(Hex)	RS232 (15)	2400 Baud
8B(Hex)	RS232 (15)	1200 Baud
8C(Hex)	Display Board (14)	net time on or off (only for program 3 with net time)
8D(Hex)	Display Board (14)	19200 Baud
8E(Hex)	Display Board (14)	9600 Baud
8F(Hex)	Display Board (14)	4800 Baud
90(Hex)	Display Board (14)	2400 Baud
91(Hex)	Display Board (14), Printer (16), and Display (1)	1/100 seconds on or off (precision)
92(Hex)	RS232 (15)	amount of LINE FEED from 0 to 9 (in ASCII)
93(Hex)	Finish delay time	finish delay time in 1/100 seconds or or off
94(Hex)	RS232 (15)	output in one string on or off
95(Hex)	Memory (RAM)	clear memory
96(Hex)	Printer (16)	19200 Baud
97(Hex)	Printer (16)	9600 Baud
98(Hex)	Printer (16)	4800 Baud
99(Hex)	Printer (16)	2400 Baud
9A(Hex)	Display Board (14)	output on interface "display board" (14) evey 1/10 or second

### Data cable from Timer S4 to PC (IBM compatible):

- o PC with 9 pin interface: cable 067-02
- o PC with 25 pin interface: cable 066-03

**Memory:**

**Memory output:** **85(Hex)**  
All times which are stored in the memory (RAM) of the Timer S4 will be transferred (e.g. to a computer) using the RS 232 interface (15) by input of hexadecimal code 85.

**85 (Hex)** output of memory on RS 232 interface (15)

**Memory output in blocks:** **84(Hex)**  
It is possible to output a block of data from the memory (RAM) of the Timer S4 using the RS 232 interface (15). You have to input the hexadecimal code 84, the first address and the last address in ASCII.

e.g.: 84(Hex)09341330 = output of all data from memory number 934 to 1330 through the RS 232 interface

**84 (Hex)** output of memory blocks on the RS 232 interface (15)

**Clear memory:** **95(Hex)**  
Input of hexadecimal 95 clears the memory (RAM). The memory can store up to 8000 times

**95(Hex)** clear memory

**Adjustment of Precision:**

You can adjust a precision of 1/10, 1/100, or 1/1000 seconds. The precision is used for the display (1), display board (14), and printer (16). The RS 232 output (15) uses always 1/1000 seconds.

**81(Hex)** 1/1000 seconds on or off

**91(Hex)** 1/100 seconds on or off

1/10 mode: 1/1000 off 1/100 off

1/100 Mode: 1/1000 off 1/100 on

1/1000 Mode: 1/1000 on 1/100 on

If you want to see the 1/1000 seconds on the display (1), you have to move the format two characters to the left by input of hexadecimal code 86. Now the display shows minutes, seconds and thousandths.

**86(Hex)** switches 1/1000 second on display (1) on or off

**Adjustment of delay time:**

You can adjust the delay time by sending the hexadecimal code 82 or 82 and then two digits for the delay time (ASCII-code). The first digit is seconds, the second digit tenth.

**82(Hex)** input of start-delay time

**83(Hex)** input of finish-delay time

With the hexadecimal code 93 you can switch from seconds and tenth to tenth and hundredths.

**93(Hex)** change finish-delay time from tenth to hundredths mode

**RS 232c interface (15):****Baud rate adjustment:**

You can change the baud rate of the RS 232 interface (15) by input of a hexadecimal code. In order to change the baud rate you have to use the actual baud rate.

<b>88(Hex)</b>	9600 baud
<b>89(Hex)</b>	4800 baud
<b>8A(Hex)</b>	2400 baud
<b>8B(Hex)</b>	1200 baud

Pre-adjusted baud rate is: 4800

**Transmission in one or two strings:****94(Hex)**

When working in program "18-Channel-Timer with time of day" a you can adjust if the time of day and net time is transmitted to the interface "display board" (14) in one or two strings. Pre-adjustment is two strings.

**94(Hex)** transmission in one or two strings for interface "display board" (14)

**Memory output:****85(Hex)**

All times which are stored in the memory (RAM) of the Timer S4 will be transferred (e.g. to a computer) using the RS 232 interface (15) by input of hexadecimal code 85.

**85 (Hex)** output of memory on RS 232 interface (15)

**Memory output in blocks:****84(Hex)**

It is possible to output a block of data from the memory (RAM) of the Timer S4 using the RS 232 interface (15). You have to input the hexadecimal code 84, the first address and the last address in ASCII.

e.g.: **84(Hex)**09341330 = output of all data from memory number 934 to 1330 through the RS 232 interface

**84 (Hex)** output of memory blocks on the RS 232 interface (15)

**LINE FEED for RS 232 interface (15):****92(Hex)**

You can adjust the amount of LINE FEED for the RS232c interface. Adjustment form 0 to 9 line feed is possible. Input first the hexadecimal code 92 and the amount of line feed in ASCII.

**92(Hex)** amount of LINE FEED from 0 to 9 (in ASCII)

**"Display Board" interface (14):****Change baud rate of Display Board interface (14):**

You can change the baud rate of the display board interface (14) by input of a hexadecimal code.

<b>8D(Hex)</b>	19200 baud
<b>8E(Hex)</b>	9600 baud
<b>8F(Hex)</b>	4800 baud
<b>90(Hex)</b>	2400 baud

Pre-adjusted baud rate is: 2400

**Display net time on display board:****8C(Hex)**

You can use the 18-Channel-Timer with time of day (see chapter 3.4.2. on page 33). Using time of day there are the following possibilities to transfer the data on the interface "display board" (15).

channel 1 = running time  
channel 2 = finish time

<b>Channel</b>	<b>Switch (5)</b>	<b>usual adjustment</b>	<b>with code 8C(Hex)</b>
channel 1	A-timer	time of day, 2400 baud	time of day + net time, 4800 baud
channel 1	B-timer	time of day, 2400 baud	time of day + net time, 4800 baud
channel 1	C-timer	net time, 2400 baud	time of day + net time, 4800 baud
channel 2	A-timer	net time, 2400 baud	net time, 4800 baud
channel 2	B-timer	net time, 2400 baud	net time, 4800 baud
channel 2	C-timer	net time, 2400 baud	net time, 4800 baud

Using hexadecimal code 8C to change to time of day and net time, it changes the baud rate automatically from 2400 to 4800 baud. A baud rate of 2400 is for this mode not possible.

**Output of running tenth:****80(Hex)**

If you want to have the tenth seconds of the running time on the interface "display board" (14) input hexadecimal code 80. If the running tenth is active it shows also the running tenth on the display (1). If you input 80(Hex) again, it turns the running tenth off.

**80(Hex)** display tenth second of running time

**Second mode or 1/10 mode:****9A(Hex)**

The "display board" interface has in the running time mode (output channel 1) an output every 1/10 second. If you want an output every second input the hexadecimal code 9A. In order to return to the 1/10 mode input again 9A(Hex).

**Printer Interface (16):****Change baud rate of Printer interface (16):**

You can change the baud rate of the printer interface (14) by input of a hexadecimal code.

<b>96(Hex)</b>	19200 baud
<b>97(Hex)</b>	9600 baud
<b>98(Hex)</b>	4800 baud
<b>99(Hex)</b>	2400 baud

Pre-adjusted baud rate is: 2400

**Display (1):**

Output of running tenth: **80(Hex)**

If you want to have the tenth seconds of the running time on the interface "display board" (14) input hexadecimal code 80. If the running tenth is active it shows also the running tenth on the display (1). If you input 80(Hex) again, it turns the running tenth off.

**80(Hex)** display tenth second of running time

**Prog. 3 special:****87(Hex)**

This mode is only effective in program 3.

With the hexadecimal code 87 you adjust the following:

dF-20	finish delay time = 0.2 seconds
dS-1.0	start delay time = 1 second
SLP 5.0	duration of displaying on display and display board = 5 seconds
TO nod	Time-out mode
nET EIn	interface "display board" (14) transfers time of day and net time
LZE EIn	running 1/10 seconds are off
TAU EIn	precision is 1/1000 seconds
HUn AUS	precision is 1/1000 seconds
AUT EIn	display automatic is on
Pri 0.0	printer output for printer with buffer
Line feed:	5 Line feed
Printer:	4800 Baud
RS232c:	output in one line without identification

e.g.: #####xHH:MM:SS.zhtxHH:MM:SS.zht(CR)(LF)(LF)(LF)(LF)

##### ..... continuous ID number (4 digits)  
HH:MM:SS.zht ..... time in hours, minutes, seconds, and 1/1000 seconds  
x ..... blank  
(CR) ..... carriage return  
(LF) ..... line feed

### **5.3. Connection for the display board:**

Connect cable 010-10 at the Timer S4 (socket "display board" (14) and at the banana sockets of the display board.

Transfer format: 1 start bit, 8 ASCII bit, no parity bit, 1 stop bit  
Transfer speed: 2400 baud  
Pin connection: see page 55

#### **Data cable from Timer S4 to display board GAZc:**

- o cable 010-10
- o extension with cable reel KT 300 or KT 500

*Attention:* You can turn the plug of cable (010-10) 180°. By turning the plug you switch between channel 1 and channel 2. It depends on the program you use and the adjustment of the options if you have different data on the two channels.

### **5.4. Connection for Printer P4 (16):**

Plug the cable of the Printer P4 at the Timer S4 (socket "printer" (16)).

Transfer format: 1 start bit, 8 ASCII bit, no parity bit, 1 stop bit  
Transfer speed: 2400 baud  
Pin connection: see page 55